



## Power Silicon Rectifier Diodes, (Stud Version), 35 A, 40 A, 60 A



DO-5 (DO-203AB)

### FEATURES

- Low leakage current series
- Good surge current capability up to 1000 A
- Material categorization: for definitions of compliance please see [www.vishay.com/doc?99912](http://www.vishay.com/doc?99912)



RoHS  
COMPLIANT

| PRIMARY CHARACTERISTICS |                  |
|-------------------------|------------------|
| $I_{F(AV)}$             | 35 A, 40 A, 60 A |
| Package                 | DO-5 (DO-203AB)  |
| Circuit configuration   | Single           |

| MAJOR RATINGS AND CHARACTERISTICS |                 |                          |                            |                          |                          |                   |
|-----------------------------------|-----------------|--------------------------|----------------------------|--------------------------|--------------------------|-------------------|
| PARAMETER                         | TEST CONDITIONS | 1N1183                   | 1N3765                     | 1N1183A                  | 1N2128A                  | UNITS             |
| $I_{F(AV)}$                       |                 | 35 <sup>(1)</sup>        | 35 <sup>(1)</sup>          | 40 <sup>(1)</sup>        | 60 <sup>(1)</sup>        | A                 |
|                                   | $T_C$           | 140 <sup>(1)</sup>       | 140 <sup>(1)</sup>         | 150 <sup>(1)</sup>       | 140 <sup>(1)</sup>       | °C                |
| $I_{FSM}$                         | 50 Hz           | 480                      | 380                        | 765                      | 860                      | A                 |
|                                   | 60 Hz           | 500 <sup>(1)</sup>       | 400 <sup>(1)</sup>         | 800 <sup>(1)</sup>       | 900 <sup>(1)</sup>       |                   |
| $I^2t$                            | 50 Hz           | 1140                     | 730                        | 2900                     | 3700                     | A <sup>2</sup> s  |
|                                   | 60 Hz           | 1040                     | 670                        | 2650                     | 3400                     |                   |
| $I^2\sqrt{t}$                     |                 | 16 100                   | 10 300                     | 41 000                   | 52 500                   | A <sup>2</sup> √s |
| $V_{RRM}$                         | Range           | 50 to 600 <sup>(1)</sup> | 700 to 1000 <sup>(1)</sup> | 50 to 600 <sup>(1)</sup> | 50 to 600 <sup>(1)</sup> | V                 |
| $T_J$                             |                 | -65 to +200              | -65 to +200                | -65 to +200              | -65 to +200              | °C                |

### Note

<sup>(1)</sup> JEDEC® registered values

## ELECTRICAL SPECIFICATIONS

| VOLTAGE RATINGS |            |            |   |   |
|-----------------|------------|------------|---|---|
| TYPE NUMBER     |            |            | $V_{RRM}$ , MAXIMUM REPETITIVE<br>PEAK REVERSE VOLTAGE<br>( $T_J = -65\text{ °C to }+200\text{ °C}$ <sup>(2)</sup> )<br>V | $V_{RM}$ , MAXIMUM DIRECT<br>REVERSE VOLTAGE<br>( $T_J = -65\text{ °C to }+200\text{ °C}$ <sup>(2)</sup> )<br>V |
| VS-1N1183       | VS-1N1183A | VS-1N2128A | 50 <sup>(1)</sup>   | 50 <sup>(1)</sup>   |
| VS-1N1184       | VS-1N1184A | VS-1N2129A | 100 <sup>(1)</sup>  | 100 <sup>(1)</sup>  |
| VS-1N1185       | VS-1N1185A | VS-1N2130A | 150 <sup>(1)</sup>  | 150 <sup>(1)</sup>  |
| VS-1N1186       | VS-1N1186A | VS-1N2131A | 200 <sup>(1)</sup>  | 200 <sup>(1)</sup>  |
| VS-1N1187       | VS-1N1187A | VS-1N2133A | 300 <sup>(1)</sup>  | 300 <sup>(1)</sup>  |
| VS-1N1188       | VS-1N1188A | VS-1N2135A | 400 <sup>(1)</sup>  | 400 <sup>(1)</sup>  |
| VS-1N1189       | VS-1N1189A | VS-1N2137A | 500 <sup>(1)</sup>  | 500 <sup>(1)</sup>  |
| VS-1N1190       | VS-1N1190A | VS-1N2138A | 600 <sup>(1)</sup>  | 600 <sup>(1)</sup>  |
| VS-1N3765       | VS-1N2160  |            | 700 <sup>(1)</sup>  | 700 <sup>(1)</sup>  |
| VS-1N3766       |            |            | 800 <sup>(1)</sup>  | 800 <sup>(1)</sup>  |
| VS-1N3767       |            |            | 900 <sup>(1)</sup>  | 900 <sup>(1)</sup>  |
| VS-1N3768       |            |            | 1000 <sup>(1)</sup>   | 1000 <sup>(1)</sup>   |

### Notes

• Basic type number indicates cathode to case. For anode to case, add "R" to part number, e.g., 1N1188R, 1N3766R, 1N1186RA, 1N2135RA

<sup>(1)</sup> JEDEC® registered values

<sup>(2)</sup> For 1N1183 Series and 1N3765 Series  $T_C = -65\text{ °C to }+190\text{ °C}$



| FORWARD CONDUCTION   |                                  |  |  |  |  |                    |                    |                   |                    |
|--|----------------------------------|--|--|--|--|--------------------|--------------------|-------------------|--------------------|
| PARAMETER  | SYMBOL                           | TEST CONDITIONS  |  | 1N1183   | 1N3765   | 1N1183A            | 1N2128A            | UNITS             |                    |
| Maximum average forward current at case temperature                        | I <sub>F(AV)</sub>               | 1-phase operation, 180° sinusoidal conduction          |  | 35 <sup>(1)</sup>  | 35 <sup>(1)</sup>                                    | 40 <sup>(1)</sup>  | 60 <sup>(1)</sup>  | A                 |                    |
|  |                                  |  |  | 140 <sup>(1)</sup>   | 140 <sup>(1)</sup>                                   | 150 <sup>(1)</sup> | 140 <sup>(1)</sup> | °C                |                    |
| Maximum peak one cycle non-repetitive surge current                        | I <sub>FSM</sub>                 | Half cycle 50 Hz sine wave or 6 ms rectangular pulse   | Following any rated load condition and with rated V <sub>RRM</sub> applied                           | 480  | 380  | 765                | 860                | A                 |                    |
|  |                                  |  |  | Half cycle 60 Hz sine wave or 5 ms rectangular pulse                                       | 500 <sup>(1)</sup>                                   | 400 <sup>(1)</sup> | 800 <sup>(1)</sup> |                   | 900 <sup>(1)</sup> |
|  |                                  | Half cycle 50 Hz sine wave or 6 ms rectangular pulse   |  | Following any rated load condition and with ½ V <sub>RRM</sub> applied following surge = 0 | 570  | 455                | 910                |                   | 1000               |
|  |                                  |  |  |  | Half cycle 60 Hz sine wave or 5 ms rectangular pulse | 595                | 475                |                   | 950                |
| Maximum I <sup>2</sup> t for fusing  | I <sup>2</sup> t                 | t = 10 ms  | With rated V <sub>RRM</sub> applied following surge, initial T <sub>J</sub> = T <sub>J</sub> maximum | 1140   | 730  | 2900               | 3700               | A <sup>2</sup> s  |                    |
|  |                                  | t = 8.3 ms   |  | 1040   | 670  | 2650               | 3400               |                   |                    |
| Maximum I <sup>2</sup> t for individual device fusing                      |                                  | t = 10 ms  | With V <sub>RRM</sub> = 0 following surge, initial T <sub>J</sub> = T <sub>J</sub> maximum           | 1610   | 1030   | 4150               | 5250               |                   |                    |
|  |                                  | t = 8.3 ms   |  | 1470   | 940  | 3750               | 4750               |                   |                    |
| Maximum I <sup>2</sup> √t for individual device fusing                     | I <sup>2</sup> √t <sup>(2)</sup> | t = 0.1 to 10 ms, V <sub>RRM</sub> = 0 following surge |  | 16 100   | 10 300   | 41 500             | 52 500             | A <sup>2</sup> √s |                    |
| Maximum peak forward voltage at maximum forward current (I <sub>FM</sub> ) | V <sub>FM</sub>                  | T <sub>J</sub> = 25 °C                                 |  | 1.7 <sup>(1)</sup>   | 1.8 <sup>(1)</sup>                                   | 1.3 <sup>(1)</sup> | 1.3 <sup>(1)</sup> | V                 |                    |
|  |                                  |  |  | 110  | 110  | 126                | 188                | A                 |                    |
| Maximum average reverse current  | I <sub>R(AV)</sub>               | Maximum rated I <sub>F(AV)</sub> and T <sub>C</sub>    |  | -  | 5.0 <sup>(1)</sup>                                   | -                  | -                  | mA                |                    |
|  |                                  |  |  | -  | 4.0 <sup>(1)</sup>                                   | -                  | -                  |                   |                    |
|  |                                  |  |  | -  | 3.0 <sup>(1)</sup>                                   | -                  | -                  |                   |                    |
|  |                                  |  |  | -  | 2.0 <sup>(1)</sup>                                   | -                  | -                  |                   |                    |
|  |                                  |  |  | Maximum rated I <sub>F(AV)</sub> , V <sub>RRM</sub> and T <sub>C</sub>                     |  | 10 <sup>(1)</sup>  | -                  |                   | 2.5 <sup>(1)</sup> |

**Notes**

- (1) JEDEC® registered values
- (2) I<sup>2</sup>t for time t<sub>x</sub> = I<sup>2</sup>√t x √t<sub>x</sub>

| THERMAL AND MECHANICAL SPECIFICATIONS                 |                   |   |  |                            |        |                    |                     |                     |
|---|-------------------|---|--|----------------------------|--------|--------------------|---------------------|---------------------|
| PARAMETER   | SYMBOL            | TEST CONDITIONS   |  | 1N1183                     | 1N3765 | 1N1183A            | 1N2128A             | UNITS               |
| Maximum operating case temperature range              | T <sub>C</sub>    |   |  | -65 to +190 <sup>(1)</sup> |        | -65 to +200        |                     | °C                  |
| Maximum storage temperature range                     | T <sub>Stg</sub>  |   |  | -65 to +175 <sup>(1)</sup> |        | -65 to +200        |                     |                     |
| Maximum internal thermal resistance, junction to case | R <sub>thJC</sub> | DC operation  |  | 1.00 <sup>(1)</sup>        |        | 1.1 <sup>(1)</sup> | 0.65 <sup>(1)</sup> | °C/W                |
| Thermal resistance, case to sink                      | R <sub>thCS</sub> | Mounting surface, smooth, flat and greased                  |  | 0.25                       |        |                    |                     |                     |
| Maximum allowable mounting torque (+ 0 %, - 10 %)     |                   | Not lubricated thread, tightening on nut <sup>(2)</sup>     |  | 3.4 (30)                   |        |                    |                     | N · m<br>(lbf · in) |
|   |                   | Lubricated thread, tightening on nut <sup>(2)</sup>         |  | 2.3 (20)                   |        |                    |                     |                     |
|   |                   | Not lubricated thread, tightening on hexagon <sup>(3)</sup> |  | 4.2 (37)                   |        |                    |                     |                     |
|   |                   | Lubricated thread, tightening on hexagon <sup>(3)</sup>     |  | 3.2 (28)                   |        |                    |                     |                     |
| Approximate weight                                    |                   |   |  | 17                         |        |                    |                     | g                   |
|   |                   |   |  | 0.6                        |        |                    |                     | oz.                 |
| Case style  |                   | JEDEC®  |  | DO-5 (DO-203AB)            |        |                    |                     |                     |

**Notes**

- (1) JEDEC registered values®
- (2) Recommended for pass-through holes
- (3) Recommended for holed threaded heatsinks

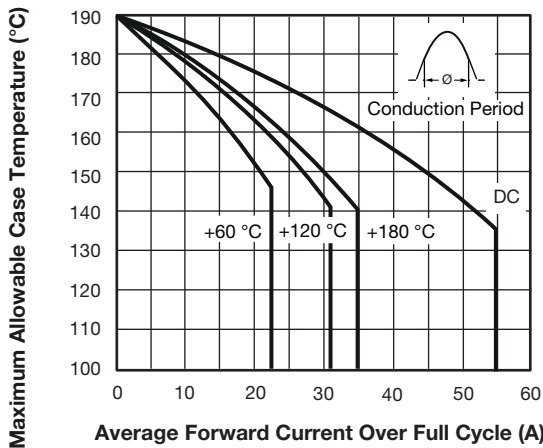

Fig. 1 - Maximum Allowable Case Temperature vs. Average Forward Current, 1N1183 and 1N3765 Series



Fig. 4 - Typical Forward Voltage vs. Forward Current, 1N1183 and 1N3765 Series

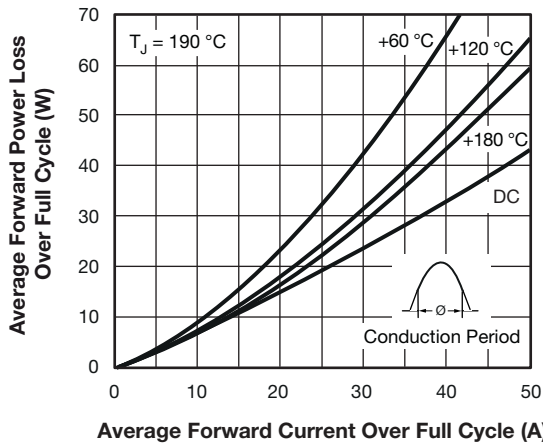

Fig. 2 - Typical Low Level Forward Power Loss vs. Average Forward Current (Sinusoidal Current Waveform), 1N1183 and 1N3765 Series

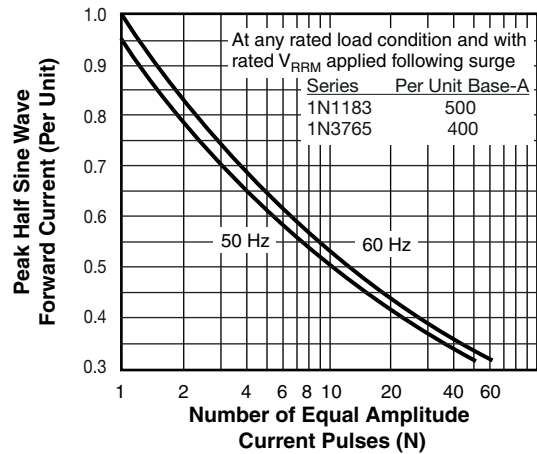

Fig. 5 - Maximum Non-Repetitive Surge Current vs. Number of Current Pulses, 1N1183 and 1N3765 Series

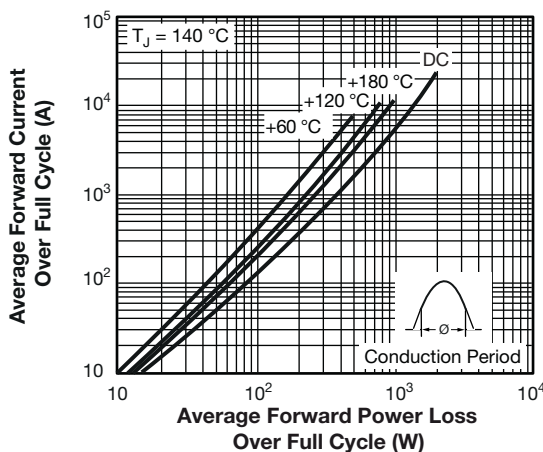

Fig. 3 - Typical High Level Forward Power Loss vs. Average Forward Current (Sinusoidal Current Waveform), 1N1183 and 1N3765 Series

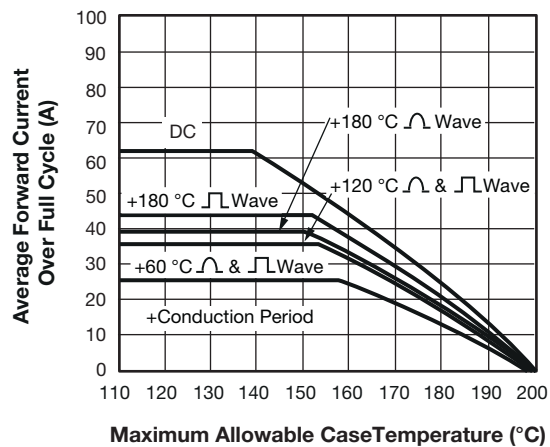

Fig. 6 - Average Forward Current vs. Maximum Allowable Case Temperature, 1N1183A Series

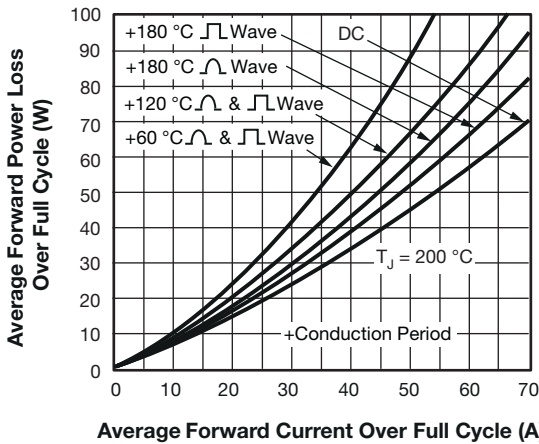

Fig. 7 - Maximum Low Level Forward Power Loss vs. Average Forward Current, 1N1183A Series

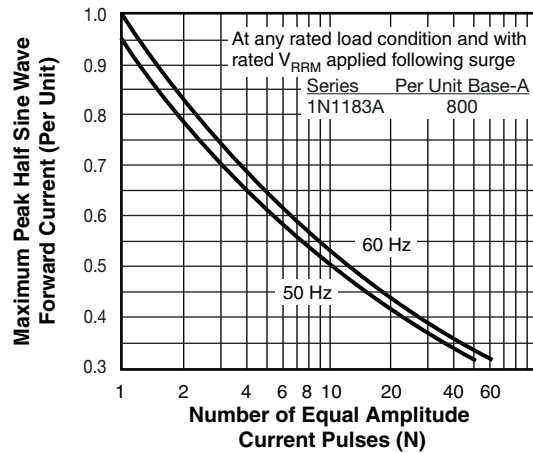

Fig. 10 - Maximum Non-Repetitive Surge Current vs. Number of Current Pulses, 1N1183A Series

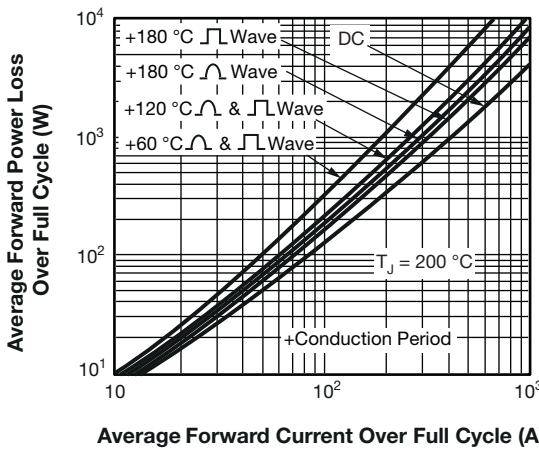

Fig. 8 - Maximum High Level Forward Power Loss vs. Average Forward Current, 1N1183A Series

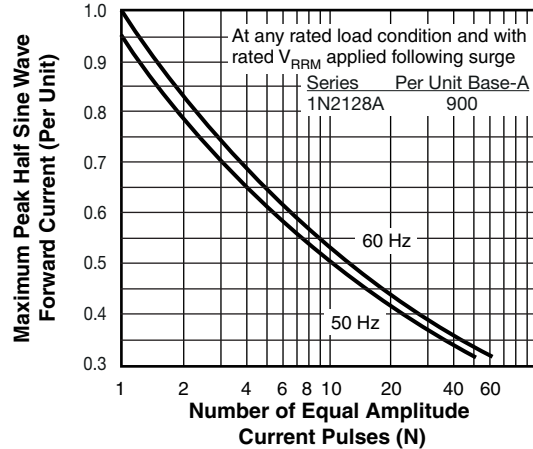

Fig. 11 - Maximum Non-Repetitive Surge Current vs. Number of Current Pulses, 1N2128A Series

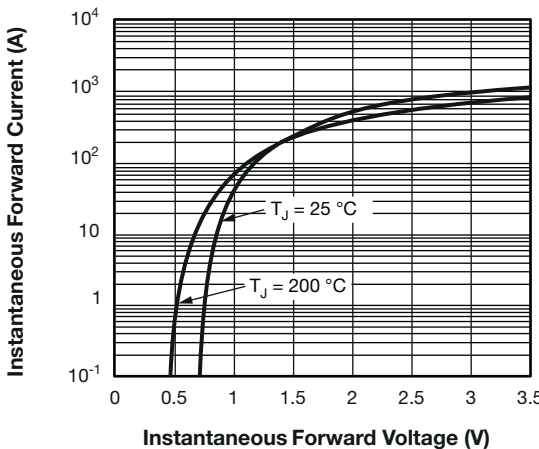

Fig. 9 - Maximum Forward Voltage vs. Forward Current, 1N1183A Series

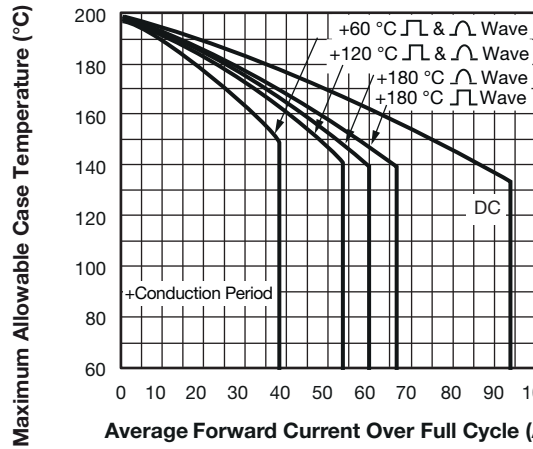

Fig. 12 - Maximum Allowable Case Temperature vs. Average Forward Current, 1N2128A Series



Fig. 13 - Maximum Low Level Forward Power Loss vs. Average Forward Current, 1N2128A Series

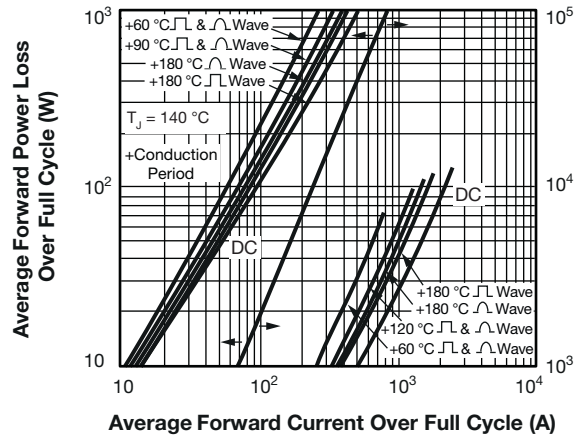

Fig. 14 - Maximum High Level Forward Power Loss vs. Average Forward Current, 1N2128A Series

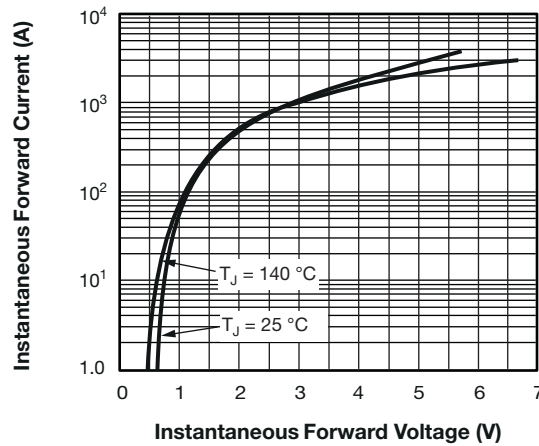

Fig. 15 - Maximum Forward Voltage vs. Forward Current, 1N2128A Series

**LINKS TO RELATED DOCUMENTS**

|            |  |
|------------|--|
| Dimensions | <a href="http://www.vishay.com/doc?95360">www.vishay.com/doc?95360</a> |
|------------|--|

## DO-203AB (DO-5) for 1N1183, 1N3765, 1N1183A, 1N2128A, 1N3208 Series

**DIMENSIONS** in millimeters (inches)

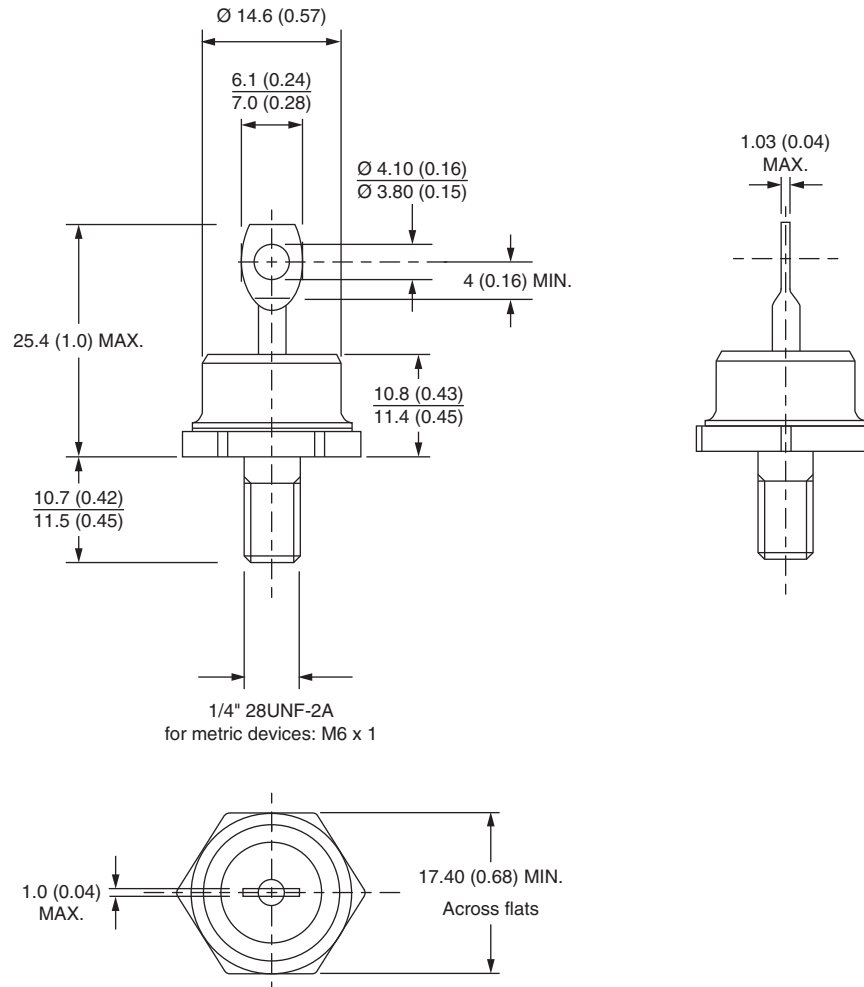



## **Disclaimer**

ALL PRODUCT, PRODUCT SPECIFICATIONS AND DATA ARE SUBJECT TO CHANGE WITHOUT NOTICE TO IMPROVE RELIABILITY, FUNCTION OR DESIGN OR OTHERWISE.

Vishay Intertechnology, Inc., its affiliates, agents, and employees, and all persons acting on its or their behalf (collectively, "Vishay"), disclaim any and all liability for any errors, inaccuracies or incompleteness contained in any datasheet or in any other disclosure relating to any product.

Vishay makes no warranty, representation or guarantee regarding the suitability of the products for any particular purpose or the continuing production of any product. To the maximum extent permitted by applicable law, Vishay disclaims (i) any and all liability arising out of the application or use of any product, (ii) any and all liability, including without limitation special, consequential or incidental damages, and (iii) any and all implied warranties, including warranties of fitness for particular purpose, non-infringement and merchantability.

Statements regarding the suitability of products for certain types of applications are based on Vishay's knowledge of typical requirements that are often placed on Vishay products in generic applications. Such statements are not binding statements about the suitability of products for a particular application. It is the customer's responsibility to validate that a particular product with the properties described in the product specification is suitable for use in a particular application. Parameters provided in datasheets and / or specifications may vary in different applications and performance may vary over time. All operating parameters, including typical parameters, must be validated for each customer application by the customer's technical experts. Product specifications do not expand or otherwise modify Vishay's terms and conditions of purchase, including but not limited to the warranty expressed therein.

Except as expressly indicated in writing, Vishay products are not designed for use in medical, life-saving, or life-sustaining applications or for any other application in which the failure of the Vishay product could result in personal injury or death. Customers using or selling Vishay products not expressly indicated for use in such applications do so at their own risk. Please contact authorized Vishay personnel to obtain written terms and conditions regarding products designed for such applications.

No license, express or implied, by estoppel or otherwise, to any intellectual property rights is granted by this document or by any conduct of Vishay. Product names and markings noted herein may be trademarks of their respective owners.