

Touch-Type Graphic Recorder

# USER MANUAL



# Notice

---

The contents of this manual are protected by the copyrights and HANYOUNG NUX exclusively has all the related rights.

Copying or reproducing all or any part of the contents of this manual without the permission of HANYOUNG NUX is strictly prohibited.

The contents of this manual are subject to change without prior notice as a result of continuing improvements to the instrument's performance and functions.

HANYOUNG NUX contains tacit guarantee and properness for certain purposes of the manual and does not provide any guarantee which is not mentioned in the manual.

The programs installed in the product are protected by the copyrights.

The software is provided "as is", without warranty of any kind, express or implied, including but not limited to the warranties of merchantability, fitness for a particular purpose and non infringement. In no event shall the authors or copyright holders be liable for any claim, damages or other liability, whether in an action of contract, tort or otherwise, arising from, out of or in connection with the software or the use of other dealings in the software.

Company and product names that appear in this manual are registered trademarks or trademarks of their respective holders. The company and product names used in this manual are not accompanied by the registered trademark or trademark symbols (® and ™).

## **HANYOUNG NUX CO., LTD.**

28, Gilpa-ro 71beon-gil, Namgu, Incheon, Korea

TEL : +82-32-876-4697 (Company)

FAX : +82-32-868-4696

<b>Before start</b>	1. Check the product	2
	2. Caution for safety	3
	3. Quality warranty	3
<b>Installation</b>	1. Cautions of Installation	4
	2. Installation method	4
	3. Dimension & Panel cutout	5
	4. Wiring	6
	5. Terminal wiring diagram	8
<b>Operation</b>	1. Names of each part	9
	2. Button operation	9
	3. How to operate the number pad	10
	4. How to operate the keypad	10
<b>Screen block diagram</b>	1. Screen block diagram	11
<b>Operating screen</b>	1. Start and end of the record	12
	2. Printing of list	14
	3. Alarm	15
	4. Trend screen	16
	5. Digital screen	17
	6. Bar graph screen	18
<b>Configuration screen</b>	1. Check the save log	19
	2. Function configuration	21
	3. Date / reservation configuration	23
	4. Channel configuration	24
	5. Alarm and DI	29
	6. History management	32
	7. System configuration	35
<b>Specifications</b>	1. Input specification	38
	2. Hardware specification	39
	3. Display specification	40
	4. Memory specification	40
	5. Installation environment	40

Before start

Installation

Operation

Screen block diagram

Operating screen

Configuration screen

Specifications





# Before start

Thank you for purchasing the graphic recorder of HANYOUNG NUX (Model : GR200).  
 The manual specifically explains the functions, how to install, caution and instruction of the product. Please carefully read and fully understand the manual.  
 In addition, let the manual used by and delivered to the end-user and keep the manual in a place ready to read.  
 (The contents of the manual may be altered without prior notice depending on the improvement or functional changes of the product.)

## 1. Check the product

After purchasing the product, please check whether the product meets your desired specification and then check the damages on the exterior or missing parts.

### ▶ Parts

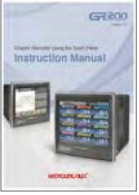
				
Main body	4 body clamps	250 Ω resistor	SD card	Manual



### ▶ Suffix code

Model	Code			Description
GR200 –	<input type="checkbox"/>	<input type="checkbox"/>	<input type="checkbox"/>	Graphic recorder
Number of channels	2			2 channel
	4			4 channel
	8			8 channel
	12			12 channel
External contact input & output (DI / DO)	N			None
	1			DI 2 contacts + DO 6 contacts (relay)
	2			DI 4 contacts + DO 12 contacts (relay)
Communication		0		RS 422/485

※Ethernet is available when using our ethernet converter(HMCE).

## 2. Caution for safety

Alerts declared in the manual are classified to Danger, Warning and Caution by their criticality

	<b>DANGER</b>	DANGER indicates an imminently hazardous situation which, if not avoided, will result in death or serious injury
	<b>WARNING</b>	WARNING indicates a potentially hazardous situation which, if not avoided, could result in death or serious injury
	<b>CAUTION</b>	CAUTION indicates a potentially hazardous situation which, if not avoided, may result in minor or moderate injury

- The contents of the manual may be altered without notification to improve the product.
- Use the product following the instructions on the safety in this manual for the protection and safety of the product and the system connected to the product.
- The company has no responsibilities for the safety issues and following damages caused by negligence or using or handling the product without following the instruction in the manual.
- Please install other additional protection or safety circuits for the protection and safety of the product and the system connected to the product outside the product.
- Do not arbitrarily disassemble, repair or modify the product. This may cause electric shock, fire or malfunction.
- Do not apply strong impact on the product. This may cause product damages or malfunction.
- When installing the product, you must install switch or a circuit breaker in order to separate it from prime power.

## 3. Quality warranty

- The company does not take any responsibility and warranty for the product not defined in the quality warranty of the company.
- The company does is not responsible for any damages to the user or the third party due to unexpected faults or the act of God, losses or indirect damages.
- The warranty period is 1 year from the date of purchase and the company provides repair services free of charge only for the cases of failure under normal condition defined in the manual.
- The repair services for failure and others after expiring the warranty period of the product are provided with charges based on the standard by the company.
- The failure below is covered with charges despite the warranty period.
  - Please contact the company or the shop you purchased if you need services (A/S) due to failure and others.
  - Failure due to user's faults (Ex : initialization due to lost password)
  - Failure due to act of God (Ex : fire, flood, etc.)
  - Failure due to moving after the product installation
  - Failure due to arbitrary modification or damages
  - Failure due to power problem including unstable power

# Installation

## 1. Cautions of Installation

- Please use the product with installed on the panel due to the danger of the electric shock.
- Do not install the product in the places below.
  - Place where a person unconsciously touches the terminal
  - Place with strong vibration, impact or electromagnetic field
  - Place with exposed to the abrasive or flammable gases
  - Place with rapid temperature change or much moisture, dust or salt
  - Place with exposed to the direct sunlight or excessively high or low temperature
  - Place with materials easy to be caught by the fire
- The case and the front part of the product are made from the plastic (PC) and equipped with insulators but do not directly install the product on the material with easily burnt.
- Do not place the equipment or wiring which causes the noise near from the product. In particular, sufficiently preheat the product when used at low temperature below 0°C. Also, do not put the equipment with severe heat near from the product.
- Turn all the gauges off and do the wiring.
- The product operates under 100 – 240 V AC / 50 – 60 Hz without additional operation. Do not use the power other than the ratings. This may cause the electric shock or the fire.
- Do not operate the product with wet hand. This may cause the electric shock.
- Please follow the existing notice to reduce the danger of the fire, electric shock or damages in use.
- Please refer to how to install for the ground, (Ground resistor: Less than 100 Ω)
- Install the product in a place with sufficient ventilation and do not cover the vent hole of the product.
- The overvoltage protection is included in the category II (IEC 60664–1) and the use environment is the Pollution Degree II.
- Do not use a sharp tool or apply too much power on the touch screen.

## 2. Installation method



Please cut off the power provided to the product before the installation. Take care not to touch the terminal due to the danger of the electric shock under the power application.

- Use the steel plate with the thickness of 2 ~ 5 mm for the panel.
- Slide the product into the panel from the front side of the panel.
- Hook the dedicated clamp to the hole on the product and fix it with bolts (Place first with slightly tightening each clamp and then fix).

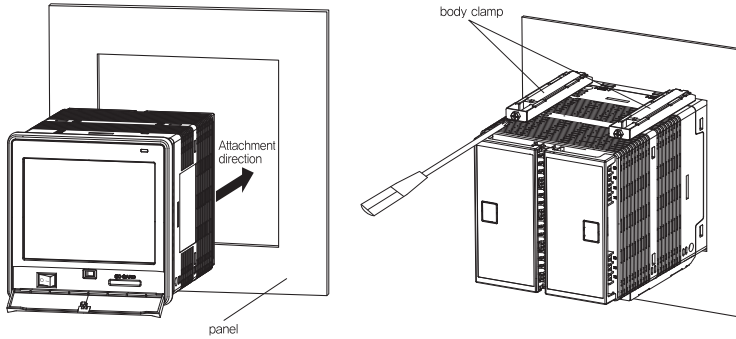

Fig. 1) How to install the panel



Caution

The tightening torque to fix the clamp is less than 0,5 Nm. Excessive torque may distort or damage the product.

### 3. Dimension & Panel cutout

#### ► Dimension (Unit : mm)

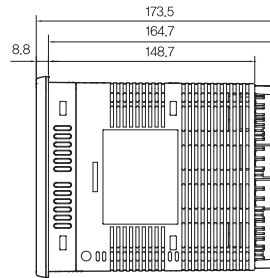
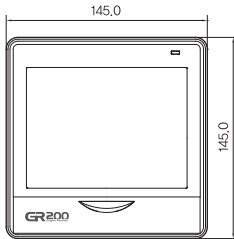

#### ► Panel cutout (Unit : mm)

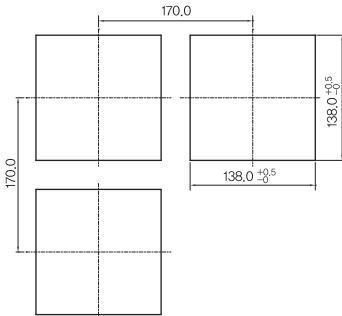

## 4. Wiring



Please cut off the power provided to the product before the wiring. Take care not to touch the terminal due to the danger of the electric shock under the power application.

### ▶ Power wiring

Please use the vinyl insulation wire with  $0.9 \sim 2.0 \text{ mm}^2$  (KSC 3304).



Much noise in the power may damage the product or malfunction. Use the line filter to remove the noise.

### ▶ FG(Frame Ground) wiring

Please use the vinyl insulation wire of  $2.0 \text{ mm}^2$  (KSC 3304).

Please wire higher than grade 3 ground with less than  $100\Omega$  of the ground resistor.

### ▶ Wire the relay output



The inductive loads (L) including the motor, solenoid and external relay cause the malfunction. Connect the CR filters and diodes with the load in parallel in the AC and the DC circuits, respectively.

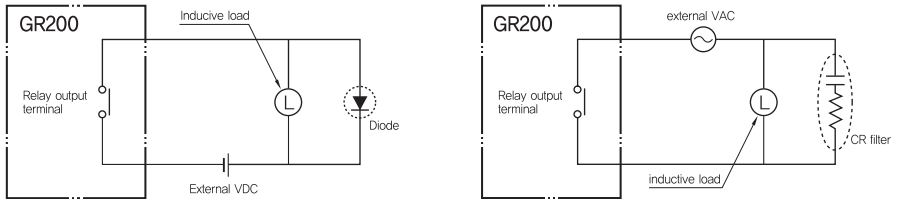

Fig. 2) Relay wiring



► **Input wiring**



Use the shield wire for the input wiring and wire with certain intervals from the power and the ground circuits. Use the RTD sensor as the 3-line sensor with the same wiring resistor.

► **Communication wiring**

Connect the terminating resistors (100 – 200 Ω, 0.25 W) at both ends of the communication line.

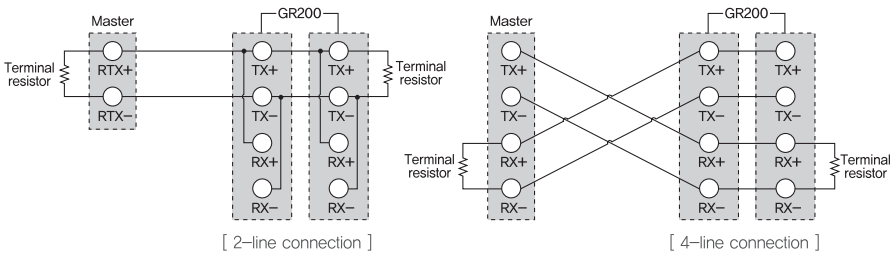
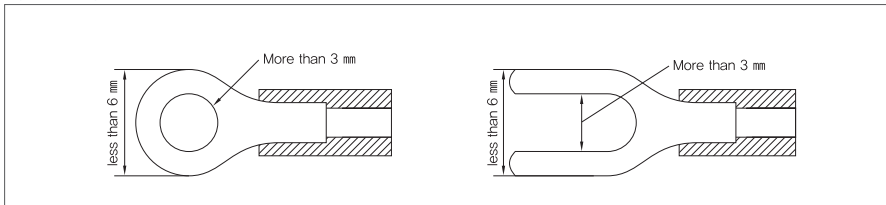

Fig. 3) Communication wiring

► **Terminal specification**

Input / output – M3 Screw



Communication / power – M3.5 Screw

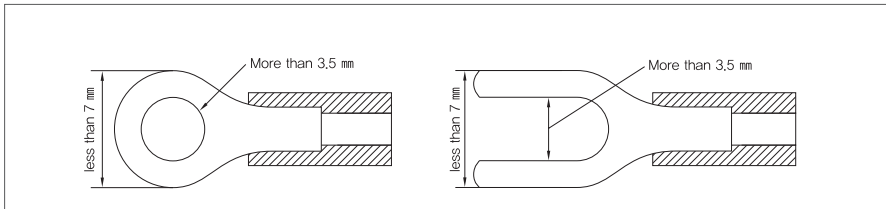

Fig. 4) Compressing terminal

# 5. Terminal wiring diagram

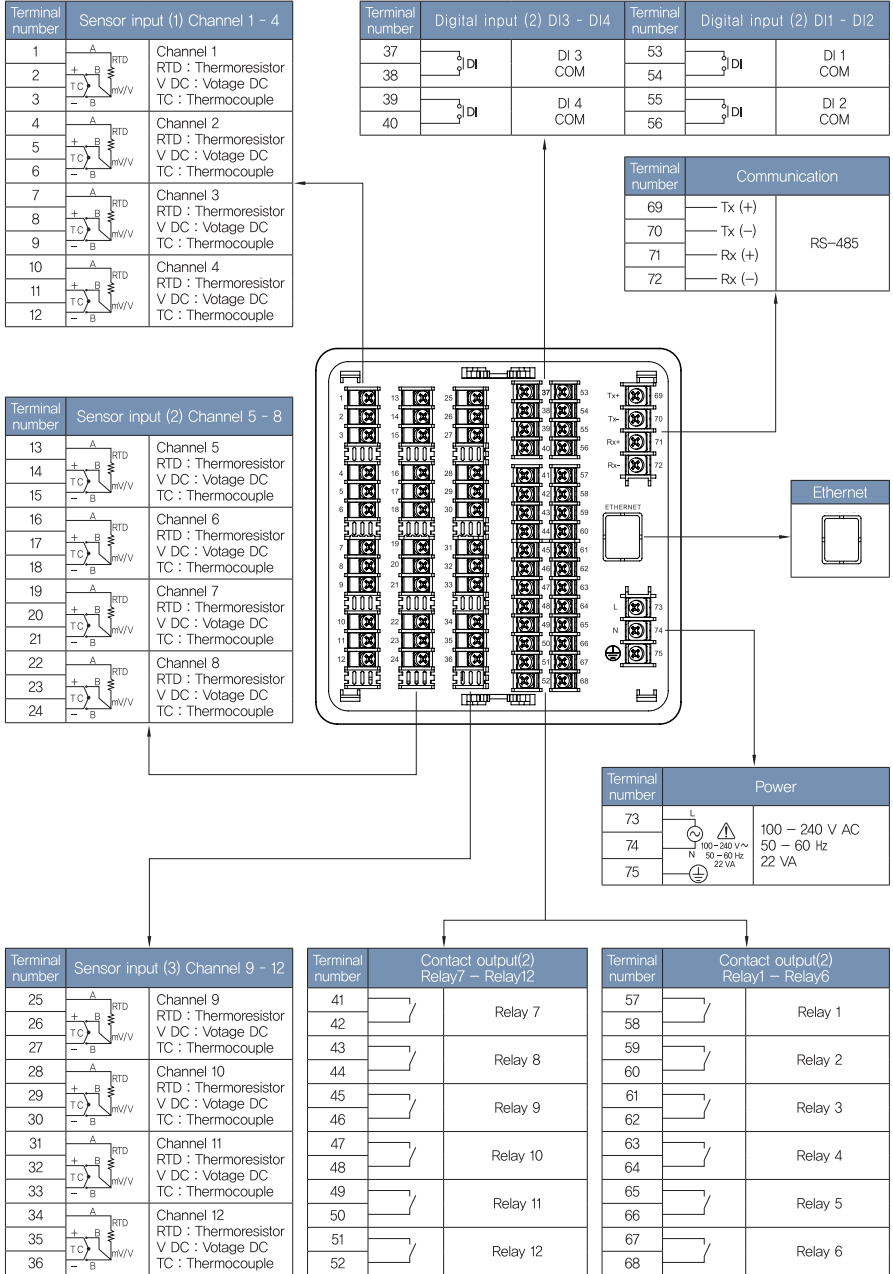

Fig. 5) Wiring diagram

# Operation

## 1. Names of each part



## 2. Button operation



	Execution button	Immediately execute the function on the button
	Select button	Select one on the list
	Input box	Display and configure the number or character. The number pad or keypad appears when pressed.

※ The execution is denied with the alarm (beep) when the button is deactivated or the configuration is prohibited.

### 3. How to operate the number pad



Fig. 6) Number pad

	Display the name and the configuration range of the parameter
	Display the configured value
	Register the configured value
	Delete the last digit of the configured value
	Delete all the configured values
	Cancel the configuration and hide the input pad.

※ The configuration is denied with the alarm (beep) if a value exceeds the configuration range.

### 4. How to operate the keypad

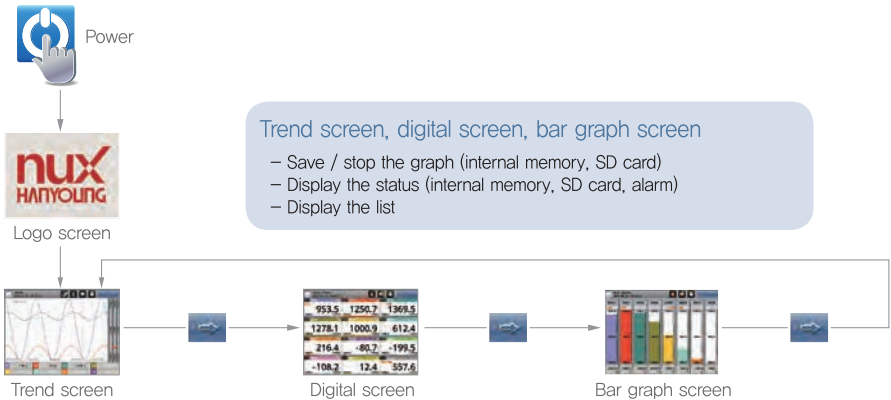

Fig. 7) Keypad

	Display the parameter name
	Display the configured character
	Register the configured character
	Delete the last digit of the configured character
	Delete all the configured values
	Cancel the configuration and hide the input pad.
	Change the character to capital or small letter
	Blank character

# Screen block diagram

## 1. Screen block diagram



Trend screen, digital screen, bar graph screen

- Save / stop the graph (internal memory, SD card)
- Display the status (internal memory, SD card, alarm)
- Display the list

	Operating screen	Trend screen, digital screen, bar graph screen
	Check the save log	View the saved graph, copy the data from the internal memory to the SD card
	Function configuration	Operation configuration : Recording interval, screen brightness, power-saving, restoration from the blackout, beep, background color, touch lock LIST : Enter the list name Graph : Line thickness, how to draw, change the saved file name
	Date / reservation configuration	Current time : Configure the current time Reservation time : Configure the reservation on start and end
	Channel configuration	Basic configuration : Sensor type, DCV range, use range, decimal point location, input filter, unit Additional configuration : Channel name, display range, how to measure, use the channel or not, channel calibration, channel copy Calculation function : Calculation configuration, enter the calculation formula, enter the memory formula
	Warning and DI	Warning configuration : Warning type, warning relay, warning operation DI configuration : Beep time, detection delay time, DI 1 operation, DI relay
	History management	Event : Display the event history, delete the event history, save to the SD card Error : Display the error history, delete the error history, save to the SD card Output status : Alarm, DI, display the relay status
	System configuration	System : Display language, select the logo screen, user password, user logo upload Product specification : Enter the information on the initial screen, whether to display the information on the initial screen, product information, parameter initialization Communication configuration : Communication protocol, communication speed, stop bit, data length, parity bit, device number, response time Memory : Memory capacity information, initialize the internal memory, parameter upload, download Firmware : Firmware upgrade, test mode

Before start  
Installation  
Operation  
Screen block diagram  
Operating screen  
Configuration screen  
Specifications

# Operating screen

## 1. Start and end of the record

The record starts and ends from the "Trend", "Digital" or "Bar Graph" screen. Use the internal memory or the SD card for record.

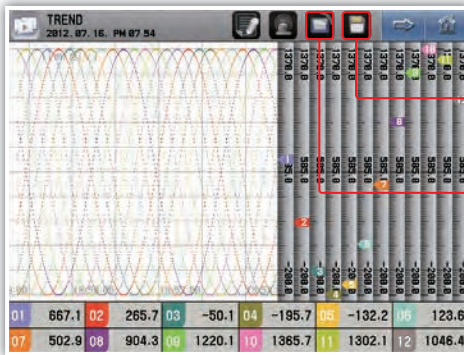

Start or end recording on the SD card.

Start or end the recording on the internal memory.

Fig. 8) Trend screen

### ▶ Record on the internal memory

Press the button to pop up the confirm screen.

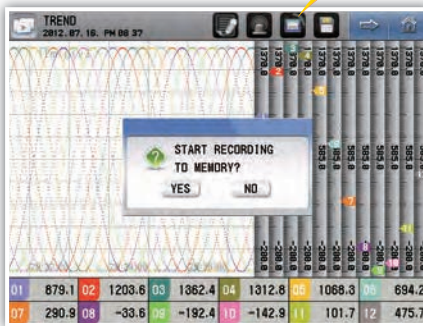

Fig. 9) Check the record in the internal memory



Fig. 10) Check the stop on the internal memory

	Display recording.
	50 % of the internal memory is used.
	The recording is terminated when 100 % of the internal memory is used.

▶ Record to the SD card

Insert the SD card as shown in the picture to record with the SD card.

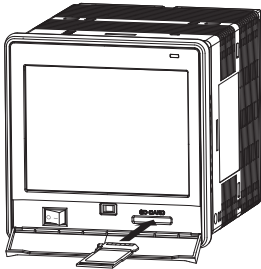

Fig. 11) Insert the SD card

- The picture shows that the SD card is recognized.
- It is not allowed to use and record with the SD card if the recognition fails.

Press the button to pop up the confirm screen.

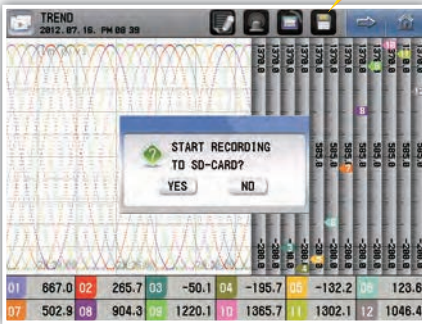

Fig. 12) Check the record on the SD card



Fig. 13) Check the stop on the SD card

	Display recording.
	50 % of the SD card is used.
	The record is automatically terminated if 100 % of the SD card is used.



Reference

The saved file name has the format of "GR200\_yymmdd\_hhmmss.GR2" and the first 6 letters may be altered in (Function configuration – Graph screen). The destination folder is the "GR200\_DATA" folder in the root directory of the SD card.



Caution

- If the number of files saved in the SD card or internal memory is more than 512, the record ends automatically
- If the capacity of the SD card or internal memory is exceeded (80 MB) the record ends automatically
- After connecting the SD card to the PC, it is recommended to check periodically the data after the back-up

Before start  
Installation  
Operation  
Screen block diagram  
Operating screen  
Configuration screen  
Specifications

## 2. Printing of list

The user may print the list on the trend screen during the record.

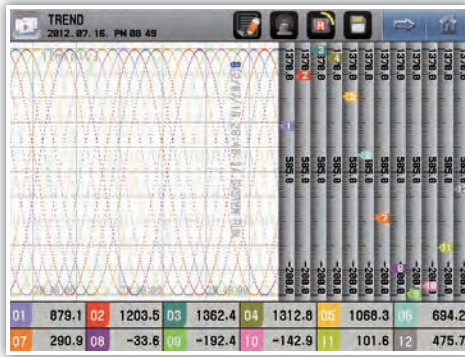

Fig. 14) Trend screen – Printed list



It is not possible to print the list when the record stops.



It is possible to print the list during the record.

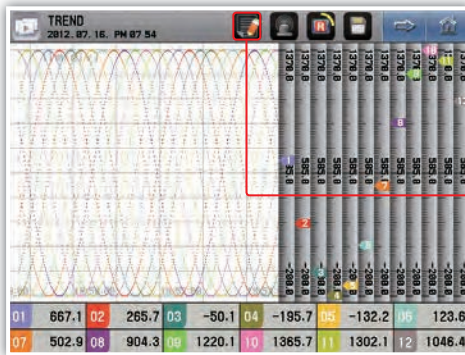

Fig. 15) Status screen – Recording

Press to show the list already recorded.

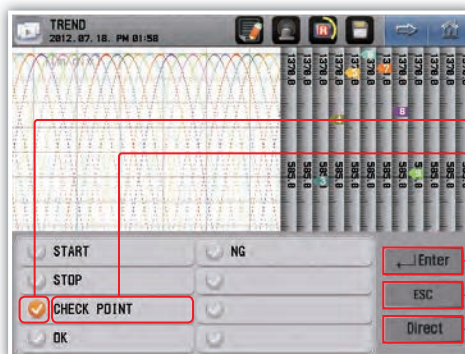



Fig. 16) List selection window

Select the list to print.

Here are the contents to print. The list may be edited in "Functional configuration" .

**Enter** → The selected list is printed on the screen.

**ESC** → Cancel to print the list.

**Direct** → Directly enter the list on the input field to print. (Max. 16 characters)



### 3. Alarm

It is possible to check the alarm on the "Trend", "Digital" or "Bar graph" screen. The alarm is configured in the "Alarm and DI" .



It is the status without the alarm.



It is the status with the alarm.

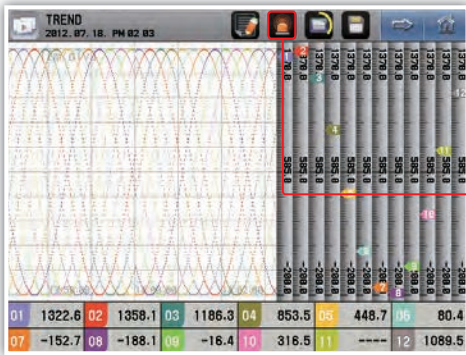

Go to the print status page to show the activated alarm.

Fig. 17) Status window – Alarming

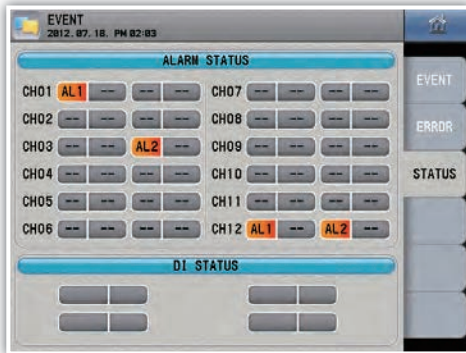

Fig. 18) Print status window

## 4. Trend screen

The screen shows the channel measurement with the graph. The graph displays the currently measured value and flows regardless of the saving. The flowing speed of the graph depends on the saving period.

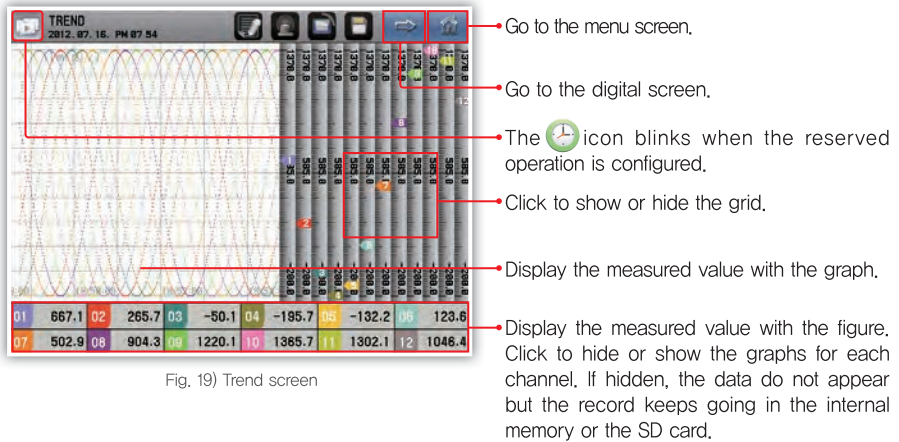

Fig. 19) Trend screen

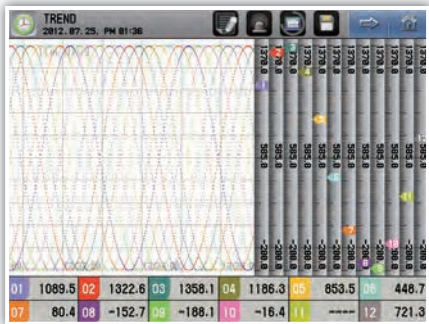

Fig. 20) Trend screen – Screen during the reservation

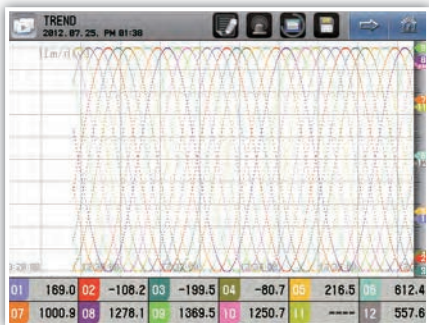

Fig. 21) Trend screen – Hide the grid

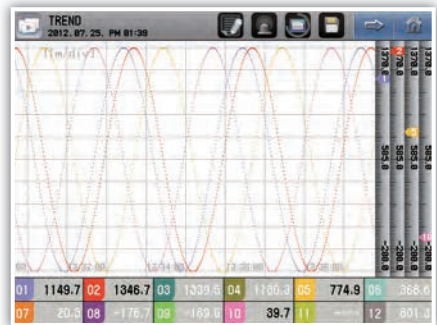

Fig. 22) Trend screen – Hide some channels

[ Display the error on the trend screen ]

Errors occurred	Display
I/O connection error	"I/O CONNECTION ERROR" blinks on the screen name
Input connection error	Display "-----"
AD error	Display "-----"
Correction error	Display "-----"
Calculation error	Display "-----"
User BURN OUT error	Display "-----"
BURN OUT error	Display "-----"
RJC error	Alternatively display "RJC" and the measured value
Out of the measurement range (-5 ~ 0 %, 100 ~ 105 %)	Alternatively display "-----" and the measured value

## 5. Digital screen

It is the screen which displays the channel measurement with numbers.

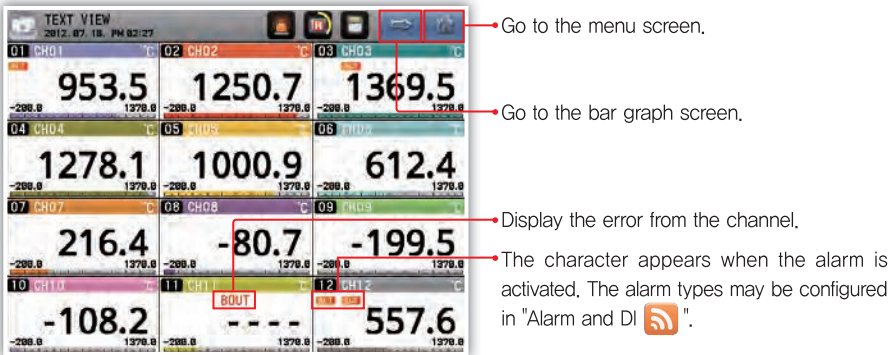
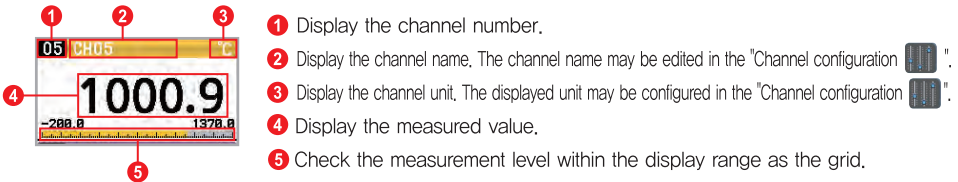

Fig. 23) Digital screen



[ Display the error on the digital screen ]

Errors occurred	Display
I/O connection error	"I/O CONNECTION ERROR" blinks on the screen name
Input connection error	"-----" displays and "CONNECT ERR" blinks
AD error	"-----" displays and "ADC" blinks
Correction error	"-----" displays and "CAL" blinks
Calculation error	"-----" displays and "CALC" blinks
User BURN OUT error	"-----" displays and "USER BOUT" blinks
BURN OUT error	"-----" displays and "BOUT" blinks
RJC error	The measured value displays and "RJC" blinks
Out of the measurement range (-5 ~ 0 %, 100 ~ 105 %)	Display the measured value and "OVER" blinks

## 6. Bar graph screen

It is the screen which displays the channel measurement with the bar. The user may check the levels of all the channels within the displayed range under current configuration at once. However, the maximum number of displayed channels is 8 and moves each channel to check the 12 channels.

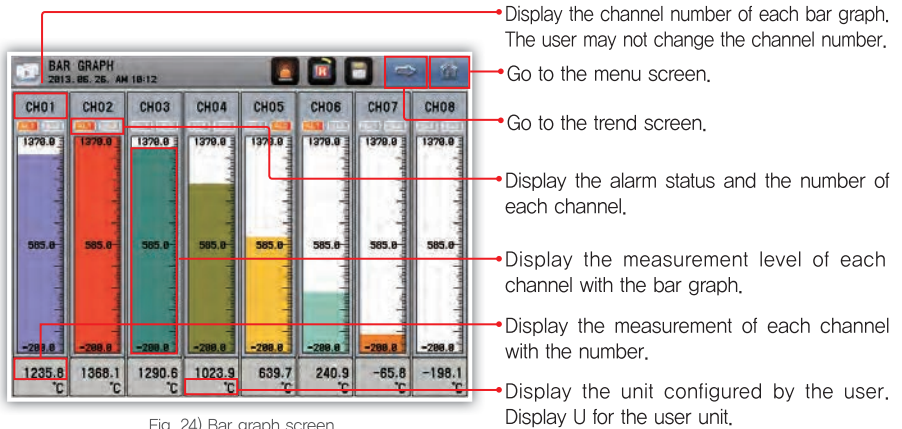

Fig. 24) Bar graph screen

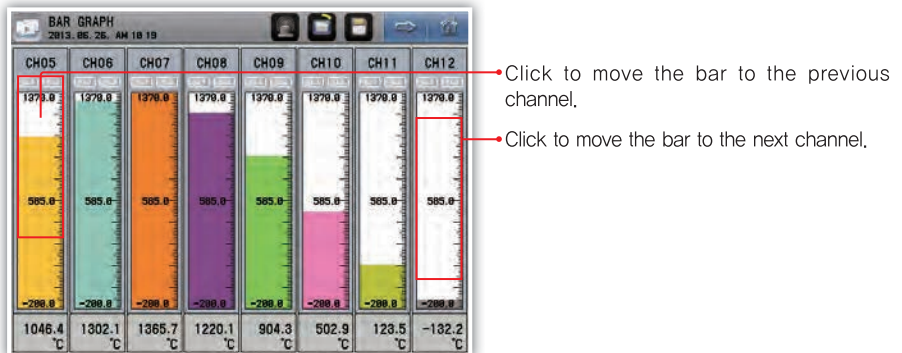

Fig. 25) Bar movement screen

# Configuration screen

## 1. Check the save log

It is possible to search up to 4 hours with the period of 1 second of the measurement of lapsed time on the operating screen.

Read the file to check it in the internal memory or the SD card as the graph.

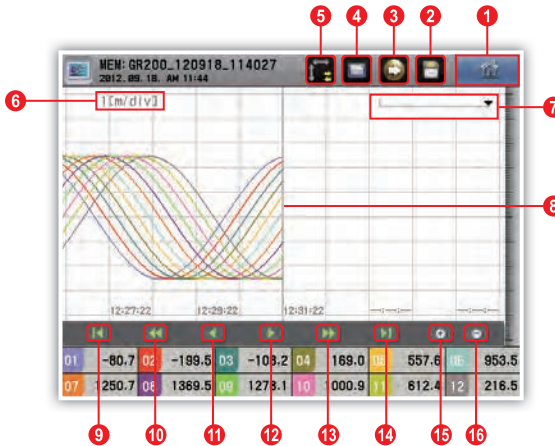

Fig. 26) View the history button – Time axis

- 1 Go to the menu screen.
- 2 Display the file recorded in the SD card. It is activated if the file is not being saved to the SD card.
- 3 Transfer the date recorded in the internal memory to the SD card. It is activated if the file is not being saved to the SD card.
- 4 Display the file recorded in the internal memory. It is activated if the file is not being saved to the internal memory.
- 5 Select the time and the size axes.
- 6 Display the time for each grid.
- 7 Display the data location indicated by the benchmark line.
- 8 It is the benchmark line for the channel display.
- 9 Go to the first part of the data.
- 10 Move to the previous page.
- 11 Move to the previous pixel. Move to every 10 or 20 pixels if long pressed.
- 12 Move to the next pixel. Move to every 10 or 20 pixels if long pressed.
- 13 Move to the next page.
- 14 Go to the end of data.
- 15 Magnify the time axis. It is impossible to magnify more than the saving period.
- 16 Reduce the time axis. The reduction ratios are 1, 2, 4, 8 and 16 times.

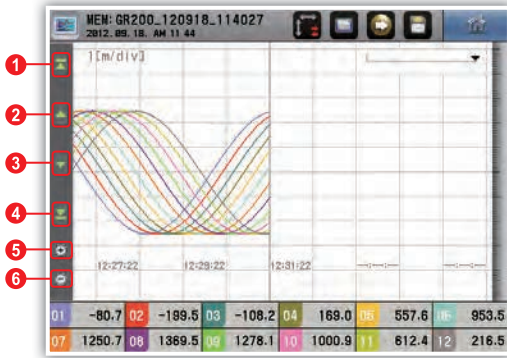
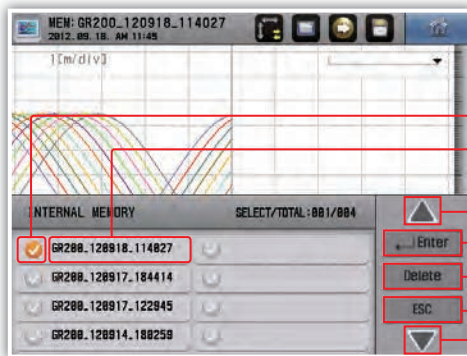

Fig. 27) View the history button – Size axis

- 1 Go to the maximum value in the data.
- 2 Move to the previous pixel. Move to every 10 or 20 pixels if long pressed.
- 3 Move to the next pixel. Move to every 10 or 20 pixels if long pressed.
- 4 Go to the minimum value in the data.
- 5 Magnify the size axis. The magnification ratios are 1, 2, 4, 8 times.
- 6 Reduce the size axis. It is impossible to reduce to less than 1.



- Select the file to read.
- Here is the file name to read. "It may be configured at 'Graph' in the 'Functional configuration' ".
- Go to the previous page.
- The graph of the selected file is displayed on the screen.
- Delete the selected file.
- Cancel the selection.
- Go to the next page.

Fig. 28) View the history display – File selection window

## 2. Function configuration

### ► Operating configuration



Fig. 29) Operating configuration screen

- Configure the data recording period. It may not be changed during saving.
- Configure to turn off the screen after the configured time. The power-saving function does not work if the time is configured to 0.
- Turn on or off buzzer sound.
- Prevent using the buttons except the trend, digital, bar graph and view history screens. (Except moving the screen)
- Enter the user password to change the touch lock parameter. The user password may be changed on the system configuration.
- Select the background color of the trend and the view saved history screens.
- The record keeps when the power turns off and on during the record.
- Adjust the background brightness.

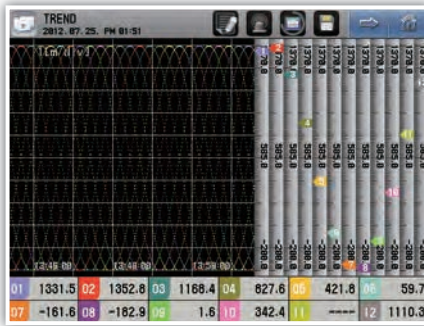

Fig. 30) Trend – Black background

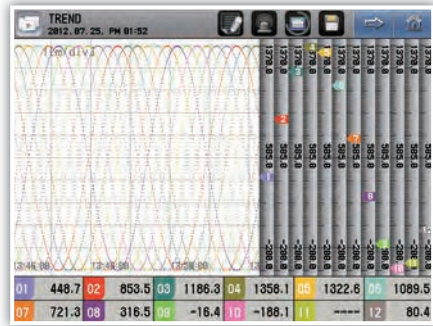
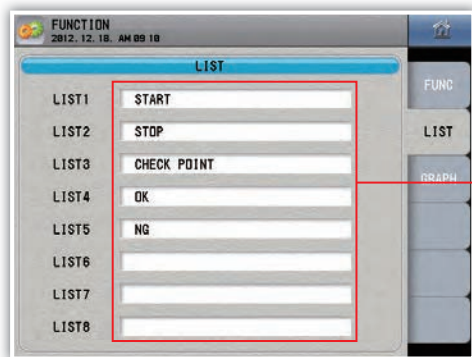

Fig. 31) Trend – White background

### [ Operation configuration parameter ]

Parameter	Initial value	Configuration range
Record interval	1	1, 2, 5, 10, 20, 30, 60, 120 seconds
Adjust the brightness	Level 3	Level 8
Power-saving	30 minutes	0 ~ 99 minutes
Restoration from the blackout	OFF	OFF, ON
Alarm	OFF	OFF, ON
Background color	Black	Black, white
Touch lock	OFF	OFF, ON

## ▶ LIST



Enter the message frequently used on the trend screen.

Fig. 32) LIST screen

### [ LIST parameter ]

Parameter	Initial value	Configuration range
LIST 1	START	Enter the text (up to 16 characters)
LIST 2	STOP	
LIST 3	CHECK POINT	
LIST 4	OK	
LIST 5	NG	
LIST 6	—	
LIST 7	—	
LIST 8	—	

## ▶ Graph

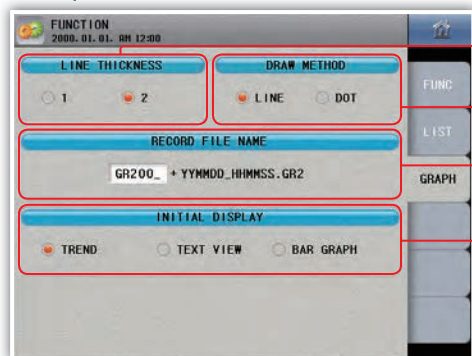

Configure the line thickness of the graph on the display.

Configure the display method of the graph.

Configure the saved file name.

The screen is shown up firstly by selecting an operating screen which you frequently use.

Fig. 33) Graph screen

### [ Graph parameter ]

Parameter	Initial value	Configuration range
Line thickness	2 pixel	1 pixel, 2 pixels
Draw method	Dot	Dot, line
Record file name	GR200_	Enter the text (up to 6 characters)
Initial operating screen	Trend screen	Trend screen, See text message, Bar graph



The file name goes back to "GR200\_" when the leading character is missing or blank.  
"/" may not be used as the file name.

Caution



### 3. Date / reservation configuration

#### ▶ Current time

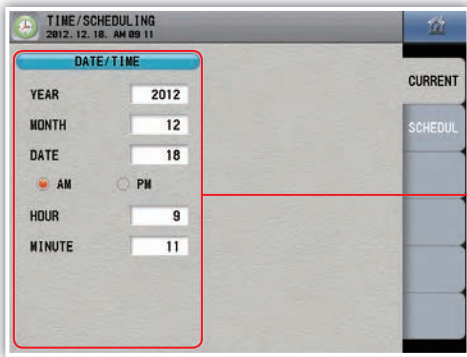

Fig. 34) Current time screen

Configure the current time.  
It may not be changed during recording.

#### ▶ Reserved time

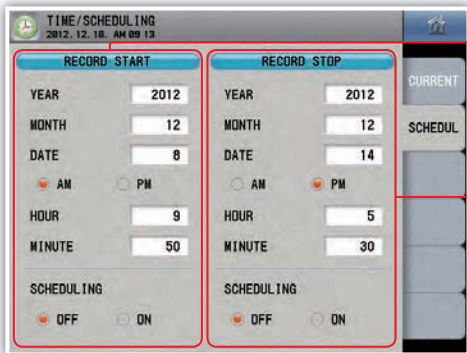

Fig. 35) Reserved time screen

Reserve the time when the record starts. It is impossible to reserve the time if the starting is ahead of the current time. It is impossible to change the reserved time during the reservation.

Reserve the time when the record ends. It is impossible to reserve the time if the ending is ahead of the current time. It is impossible to change the reserved time during the reservation.

#### [ Time configuration parameter ]

Parameter	Configuration range
Year	2000 ~ 2099
Month	1 ~ 12
Date	1 ~ 31
AM/PM	AM, PM
Hour	1 ~ 12
Minute	0 ~ 60
Scheduling	ON, OFF

## 4. Channel configuration

### ► Basic configuration

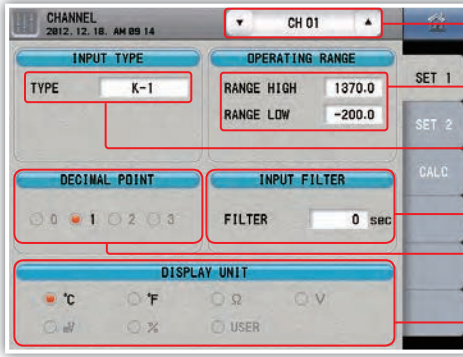

Select the channel.

Enter the value of the range to use. It may not be changed during recording.

Select the sensor type. It may not be changed during recording.

Enter the input digital filter.

The decimal point location is fixed if the sensor is the thermoresistor or the thermocouple.

Configure °C or °F. It may not be changed during recording.

Fig. 36) Basic configuration : RTD, TC

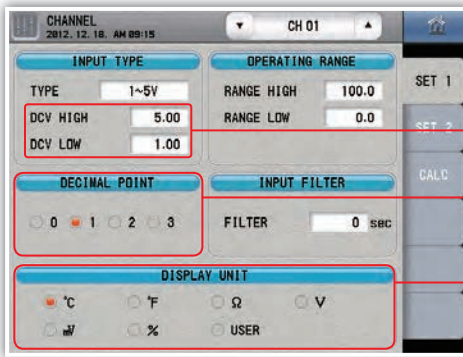

Configure the VDC input value if the sensor is VDC. It may not be changed during recording.

Configure the decimal point location if the sensor is VDC. It may not be changed during recording.

Configure the display unit, (°C, °F, Ω, V, mV, %, user) Select the user to directly enter the character. It may not be changed during recording.

Fig. 37) Basic configuration : DCV



Caution

The channel configuration and the alarm configuration are initialized if the sensor type, range and display unit change for the thermoresistor and the thermocouple. Change the sensor type and the range to initialize the channel configuration and the alarm configuration for the VDC sensor.

**[ Basic channel configuration parameter ]**

( nn : Channel number )

Parameter	Initial value	Configuration range
Sensor type	K-1	Refer to the table of the ranges for sensor types
DCV input upper limit	DCV upper limit	Within the DCV sensor range
DCV input lower limit	DCV lower limit	Within the DCV sensor range
Upper limit of the use range	Use range (100 %)	Use range (0 ~ 100 %)
Lower limit of the use range	Use range (0 %)	Use range (0 ~ 100 %)
Decimal point location	1	0, 1, 2, 3
Input filter	0 second	0 ~ 120 seconds
Displayed unit	°C	°C, °F, Ω, V, mV, %, user
User	UNITnn	Enter the text (up to 6 characters)

**[ Range for the sensor types – RTD, TC ]**

Sensor type			Use range	Decimal point range	Use range	Decimal point range
			°C		°F	
Thermoresistor (R.T.D)	Pt100	Pt - 0	-200 ~ 640	0	-300 ~ 1180	0
		Pt - 1	-200.0 ~ 640.0	1	-300.0 ~ 1180.0	1
		Pt - 2	-100.00 ~ 150.00	2	-300.0 ~ 1180.0	1
	KPt100	KPt - 0	-200 ~ 500	0	-300 ~ 1000	0
		KPt - 1	-200.0 ~ 500.0	1	-300.0 ~ 1000.0	1
		KPT - 2	-100.00 ~ 150.00	2	-300.0 ~ 1000.0	1
Thermocouple (T.C)	K	K - 0	-200 ~ 1370	0	-300 ~ 2500	0
		K - 1	-200.0 ~ 1370.0	1	-300 ~ 2500	0
	J	-200.0 ~ 1200.0	1	-300 ~ 2300	0	
	E	-200.0 ~ 1000.0	1	-300 ~ 1800	0	
	T	-200.0 ~ 400.0	1	-300 ~ 750	0	
	R	0.0 ~ 1700.0	1	0 ~ 3100	0	
	B	0.0 ~ 1800.0	1	0 ~ 3300	0	
	S	0.0 ~ 1700.0	1	0 ~ 3100	0	
	L	-200.0 ~ 900.0	1	-300 ~ 1300	0	
	N	-200.0 ~ 1300.0	1	-300 ~ 2400	0	
	U	-200.0 ~ 400.0	1	-300 ~ 750	0	
	Wre 5 - 26	0.0 ~ 2300.0	1	0 ~ 4200	0	
	PL-II	0.0 ~ 1390.0	1	0 ~ 2500	0	

**[ Range for the sensor types – DCV ]**

Sensor type	DCV input range	Use range	Decimal point range
VDC	-10.00 - 20.00	Decimal point = 0 : -10000 ~ 20000	0 ~ 3
	0.00 - 100.00	Decimal point = 1 : -1000.0 ~ 2000.0	
	1.00 - 5.00	Decimal point = 2 : -100.00 ~ 200.00	
	0.00 - 30.00	Decimal point = 3 : -10.000 ~ 20.000	

Before start

Installation

Operation

Screen block diagram

Operating screen

Configuration screen

Specifications

## ▶ Additional configuration

Enter the range to be displayed on the operating screen (trend, digital).

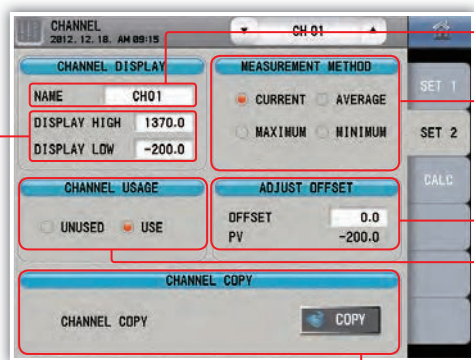

Configure the channel name. It may not be changed during recording.

Configure how to measure the data. The average, minimum and maximum calculation times of the measurement value are the same with the recording period. It may not be changed during recording.

Configure use / not use the channel. The data are not saved to the internal memory or the SD card if not used. It may not be changed during recording.

Calibrate the error during the measurement.

Copy the parameter currently configured to one channel and apply the parameter to another channel. The copy affects the following current channel but does not affect the previous channel. Here, the channel name is not copied. In addition, it does not work during recording.

Fig. 38) Additional configuration screen

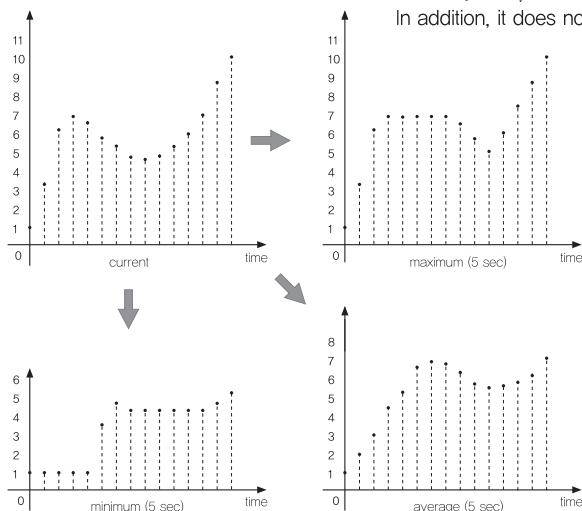

Fig. 39) Example of data collection (current, maximum, minimum, average)

### [ Basic channel configuration parameter ]

( nn : Channel number )

Parameter	Initial value	Configuration range
Name	CHnn	Enter the text (up to 8 characters)
Display high	Use range (100 %)	Use range (0 ~ 100 %)
Display low	Use range (0 %)	Use range (0 ~ 100 %)
Measurement method	Current	Current, average, maximum, minimum
Channel usage	Use	Unused, Use
Adjust offset	Use range (0 %)	Use range (-100 ~ 100 %)

► Calculation function

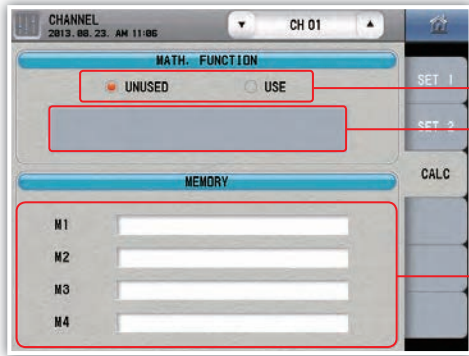

Decide whether to use the calculation function.

It is the input window of the calculation formula. (Up to 79 characters)

It is the input window of the memory formula (up to 25 characters). 4 memory variables may be configured and are commonly used in the channels.

Fig. 40) Calculation function screen



Fig. 41) Calculation input screen

[ Calculation function ]

Formula	Caution	Function	Description
+ - x /	(Caution 1)	4 fundamental arithmetic calculations	-
^	-	Involution	-
%	(Caution 2)	Remaining calculations	-
←	-	Move one space to the left	-
→	-	Move one space to the right	-
CLR	-	Clear all	-
BS	-	Delete the left character from the cursor	-
ENTER	-	Confirm	-
ESC	-	Cancel	-
M	-	Select the memory variable	M2
CH	-	Select the channel value	CH2
SIN ( · )	-	Sine value	SIN (CH2) → The sine value of the CH2
COS ( · )	-	Cosine value	COS (CH2) → The cosine value of the CH2
TAN ( · )	(Caution 3)	Tangent value	TAN (CH2) → The tangent value of the CH2
MAX ( : )	-	Maximum value	MAX (CH1, CH4) → Maximum value of the CH1 and the CH4 MAX (CH1 : CH4) → The maximum value between the CH1, CH2, CH3 and CH4

Before start  
Installation  
Operation  
Screen block diagram  
Operating screen  
Configuration screen  
Specifications

Formula	Caution	Function	Description
MIN ( : )	—	Minimum value	MIN (CH1, CH4) → Minimum value of the CH1 and the CH4 MIN (CH1 : CH4) → The minimum value between the CH1, CH2, CH3 and CH4
ASIN ( · )	(Caution 4)	Inverse value of the sine	ASIN (CH2) → The inverse sine value of the CH2
ACOS ( · )	(Caution 4)	Inverse value of the cosine	ACOS (CH2) → Inverse value of the cosine CH2
ATAN ( · )	—	Inverse value of the tangent	ATAN (CH2) → Inverse value of the tangent CH2
HUMI ( · · )	(Caution 5)	Conversion value of the relative humidity	HUMI (CH1, CH2) → The relative humidity with the dry bulb temperature of the CH1 and the wet bulb temperature of the CH2
ABS ( · )	—	Absolute value	ABS (CH2) → The absolute value of the CH2
D2R ( · )	—	Convert the degree to the radian	D2R (CH2) → Convert the CH2 to the radian
INV ( · )	(Caution 6)	Inverse value	INV (CH2) → Inverse value of the CH2
CTAN ( · )	(Caution 7)	Inverse value of the tangent	CTAN (CH2) → The inverse tangent value of the CH2
PCT ( · · · )	—	x / (Hi - Lo)	PCT (x, Hi, Low) → x: Target value, Hi: Maximum value, Lo: Minimum value
SQRT ( · )	(Caution 8)	Square root value	SQRT (CH2) → The square root of the CH2
EXP ( · )	(Caution 9)	Involution of e	EXP (CH2) → The value of involution of e to the CH1
LN ( · )	(Caution 10)	Natural log value	LN (CH2) → The natural value with e and the antilogarithm of the CH2
LOG ( · )	(Caution 10)	Commercial log	LOG (CH2) → The natural value with e and the antilogarithm of the CH2

※ ( · ) : Single variable ( · · ) : 2 variables with the separation of ", "  
 ( : ) : 2 variables with the calculation of ", " : Calculation of continuous values ( · · · ) : 3 variables with the separation of ", "

- (Caution 1) The calculation error occurs when divided with "0".
- (Caution 2) The error occurs when the calculation is done with "0" or minus value.
- (Caution 3) The error occurs when the tangent value is calculated with  $\pm(2n-1) \times (\pi/2)$ .
- (Caution 4) The inverse sine and cosine functions show calculation errors either below "-1" or over "1".
- (Caution 5) The result is effective in  $0 < \text{wet bulb} < \text{dry bulb} < 100$  based on the theory of the relative humidity.
- (Caution 6) The calculation error occurs if the denominator is "0".
- (Caution 7) The calculation error occurs at  $\pm n \times \pi$ .
- (Caution 8) The imaginary number is not supported and the calculation error occurs if the value in the root is below 0.
- (Caution 9) The involution of e is limited from -9 to 9 due to the digit display.
- (Caution 10) The calculation error occurs if the antilogarithm of the log is less than 0.

The calculation error occurs if the calculation formula referring to the channel is referred.  
 EX) CH1 calculation formula : SIN(CH2), CH2 calculation formula : For COS(CH1)

Caution

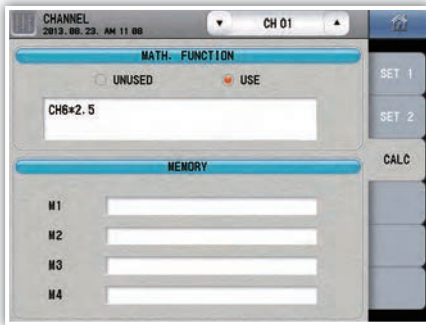

Fig. 42) Example of using the calculation formula 1

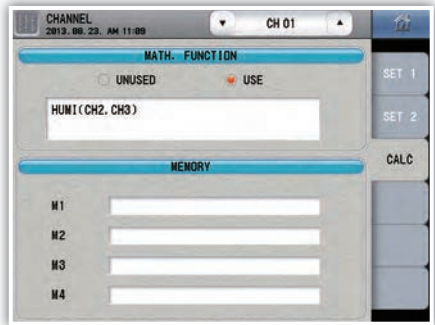

Fig. 43) Example of using the calculation formula 2

(Fig. 42) is the example of the configuration as an example of using the calculation formula which displays the multiplication of the CH6 with 2,5 to the channel 1.

(Fig. 43) is the example of the configuration as an example of receiving the temperature from the channel 2 and channel 3 as the dry bulb temperature and the wet bulb temperature, respectively.

## 5. Alarm and DI

### ► Alarm configuration

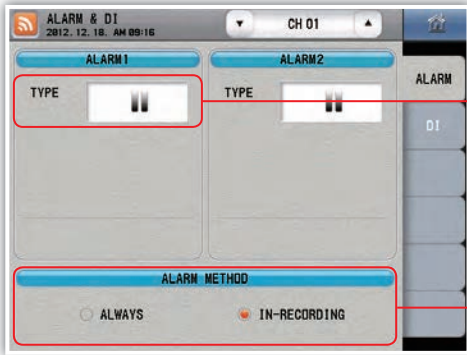

Configure the alarm type.

Configure the operating condition of the alarm.

Fig. 44) Alarm configuration screen



Fig. 45) Alarm selection screen

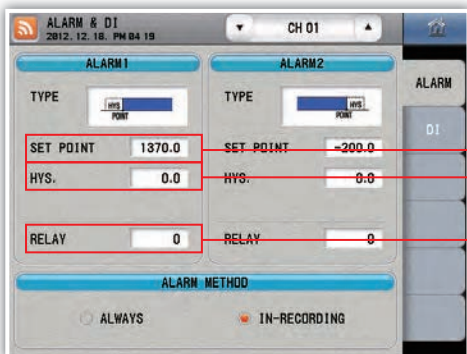

Enter the alarm configuration value.

Enter the hysteresis.

Configure the relay operated under the alarm.

Fig. 46) Select the alarm 1 : Upper limit / lower limit

Before start

Installation

Operation

Screen block diagram

Operating screen

Configuration screen

Specifications



Enter the upper limit of the alarm operation,  
 Enter the lower limit of the alarm operation,

Fig. 47) Select the alarm 1 – Within the range / out of the range of the upper and the lower limits

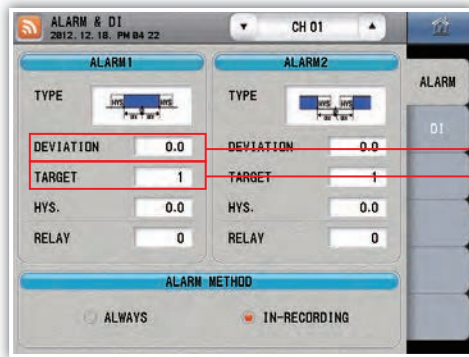

Enter the deviation with the channel for comparison,  
 Enter the channel for comparison,

Fig. 48) Select the alarm 1 – Within / out of the range among channels



The operation point may differ from the configuration value for different sensors among the comparison channels.

※ The alarm 2 is the same with the alarm 1.

[ Alarm type ]

Alarm type (▲ : Deviation, ▲Warning SV)	Description
	Upper limit warning
	Lower limit warning
	Warning within the upper and the lower limits
	Warning out of the upper and the lower limits
	Warning within the deviation among the channels
	Warning out of the deviation among the channels



[ Alarm configuration parameter ]

Parameter	Initial value	Configuration range
Alarm type	Not use	Not use, upper limit, lower limit, within the range, out of the range, within the deviation among the channels, out of the deviation among the channels
Configuration	High point : Use range (100 %), Low point : Use range (0 %)	Use range (0 ~ 100 %)
High point	Within : Use range (0 %), out of : Use range (100 %)	
Low point	Use range (0 %)	
Deviation	Use range (0 %)	
Target	Own channel	1 ~ 12
HYS	Use range (0 %)	Use range (0 ~ 100 %)
Relay	0	0 ~ 12 (depending on the specification)
Alarm method	In recording	Always, In recording

▶ DI configuration

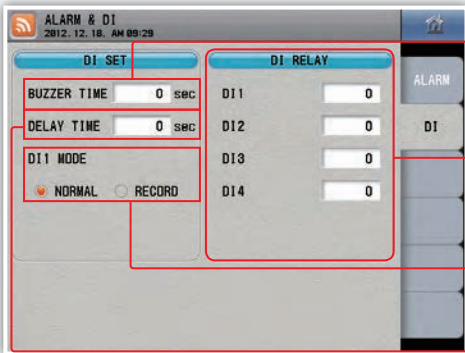

Enter the time of keeping the alarm for the external contact input (DI).

Configure the relay operating under the external contact input (DI). The DI 1 relay is deactivated if the operation method is configured to save.

Configure the functions of the DI 1 operation. (General, save) The saving works during the DI 1 input when configured to the save.

Enter the time delay after the external contact input (DI).

Fig. 49) Di configuration screen

[ DI configuration parameter ]

Parameter	Initial value	Configuration range
Buzzer Time	0 second	0 ~ 9999 seconds
Delay time	0 second	
DI 1 Mode	Normal	Normal, Record
DI 1	0	0 ~ 12 (depending on the specification)
DI 2	0	
DI 3	0	
DI 4	0	

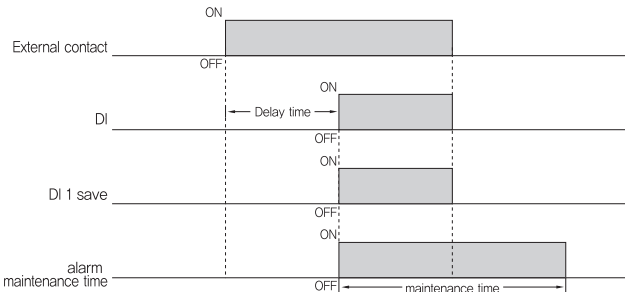



Reference  
The alarm from the operation of the DI turns off regardless of the maintenance time when the screen is touched.

Fig. 50) Operation depending on the DI configuration

# 6. History management

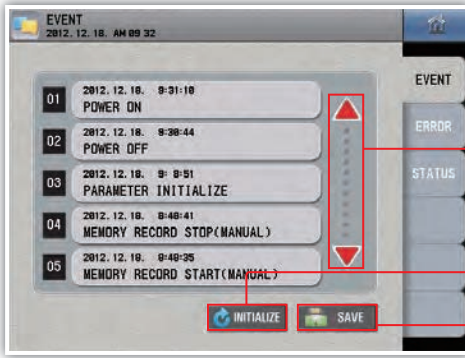
## ▶ Event



 The saved file name has the format of "EV\_ yymmdd.TXT". The destination folder is the "GR200\_EVENT" folder in the root directory of the SD card.

Check by circulating a total of 80 event histories.

Initialize the event history. (Not work during recording)

Save the event history to the SD card. (Not work during recording)

Fig. 51) Event screen

### [ Event message ]

Event message	Description
POWER ON	-
POWER OFF	-
SD CARD RECORD START(MANUAL)	Start saving to the SD card by touching the screen
SD CARD RECORD STOP(MANUAL)	Stop saving to the SD card by touching the screen
MEMORY RECORD START(MANUAL)	Start saving to the internal memory by touching the screen
MEMORY RECORD STOP(MANUAL)	Stop saving to the internal memory by touching the screen
SD CARD INSERT	-
SD CARD EJECT	-
SD CARD RECORD START(DI1)	Save the DI operation method and start saving to the SD card as a contact
SD CARD RECORD STOP(DI1)	Save the DI operation method and stop saving to the SD card as a contact
MEMORY RECORD START(DI1)	Save the DI operation method and start saving to the internal memory as a contact
MEMORY RECORD STOP(DI1)	Stop the DI operation method and start saving to the internal memory as a contact
SD CARD RECORD START(RESERVE)	Start the saving to the SD card with starting the reservation function
SD CARD RECORD STOP(RESERVE)	Stop the saving to the SD card with ending the reservation function
MEMORY RECORD START(RESERVE)	Start the saving to the internal memory with starting the reservation function
MEMORY RECORD STOP(RESERVE)	Stop the saving to the internal memory with ending the reservation function
SD CARD RECORD START(COMM)	Start saving to the SD card with the communication program
SD CARD RECORD STOP(COMM)	Stop saving to the SD card with the communication program
MEMORY RECORD START(COMM)	Start saving to the internal memory with the communication program
MEMORY RECORD STOP(COMM)	Stop saving to the internal memory with the communication program
SD CARD RECORD START(BOOT)	Start saving to the SD card with the blackout restoration
MEMORY RECORD START(BOOT)	Start the saving to the internal memory with the blackout restoration function
SD CARD RECORD STOP(NO MEMORY)	Terminate the saving to the SD card due to abnormal situation
SD CARD RECORD STOP(MEM_FULL)	Terminate the saving to the SD card due to insufficient capacity
MEMORY RECORD STOP(MEM_FULL)	Terminate saving to the internal memory due to excessive capacity (80MB)
SD CARD RECORD STOP(FILE_FULL)	Terminate saving to the SD card due to excessive number of files (512)
MEMORY RECORD STOP(FILE_FULL)	Terminate saving to the internal memory due to excessive number of files (512)
INTERNAL MEMORY INITIALIZE	Initialize the data files stored to the internal memory
PARAMETER INITIALIZE	Initialize the parameter configuration (including sensor type)
SD CARD PARAMETER UPLOAD	Upload the parameter to the SD card
PARAMETER INITIALIZE(SUM ERROR)	Initialize the parameter to the SUM ERROR when booted

▶ Error

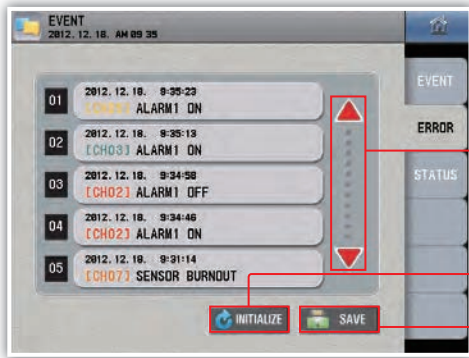

Reference  
The saved file name has the format of "ERR\_yymmdd.TXT". The destination folder is the "GR200\_EVENT" folder in the root directory of the SD card.

Check by circulating a total of 40 error histories.

Initialize the error history.  
(Not work during recording)

Save the error history to the SD card.  
(Not work during recording)

Fig. 52) Error screen

[ Error message ]

( nn : Channel number )

Error message	Description
[CHnn] ALARM1 ON	—
[CHnn] ALARM1 OFF	—
[CHnn] ALARM2 ON	—
[CHnn] ALARM2 OFF	—
DI1 ON	External contact input 1 (DI 1) contact ON
DI1 OFF	External contact input 1 (DI 1) contact OFF
DI2 ON	External contact input 2 (DI 2) contact ON
DI2 OFF	External contact input 2 (DI 2) contact OFF
DI3 ON	External contact input 3 (DI 3) contact ON
DI3 OFF	External contact input 3 (DI 3) contact OFF
DI4 ON	External contact input 4 (DI 4) contact ON
DI4 OFF	External contact input 4 (DI 4) contact OFF
[CHnn] SENSOR BURNOUT	—
[CHnn] RJC ERROR	Inferior input of the reference junction compensation (RJC) for the channel
[CHnn] ADC ERROR	Inferior AD input of the channel
[CHnn] CAL ERROR	The channel is not corrected
[CHnn] INPUT CONNECTION ERROR	Not communication with the input board on the channel
I/O CONNECTION ERROR	Fail communication with the input/output board (DI/DO)

Before start

Installation

Operation

Screen block diagram

Operating screen

Configuration screen

Specifications

## ► Output status

It is the screen which shows the alarm status and the external contact input/output for each channel.



Fig. 53) Output status window

It shows the alarm status.

--	No alarm configuration
AL1 AL2	Alarm configuration + no alarm activated
AL1 AL2	Alarm configuration + alarm activated

It shows the relay status.

--	Not configure the relay
RY01	Configure the relay + no relay activated
RY01	Configure the relay + relay activated

It shows the status of the DI.

D. I: 1	No DI
D. I: 1	With DI

## 7. System configuration

### ▶ System

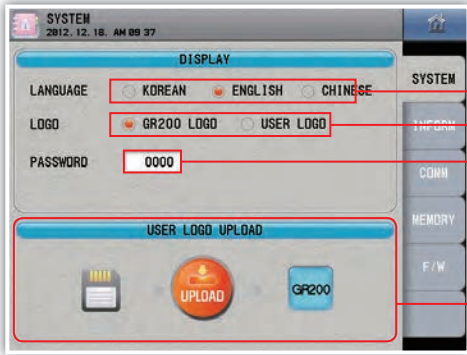

Fig. 54) System window

- Select the language (Korean / English / Chinese).
- Select the logo displayed for the booting.
- Configure the user password to check the password to change the touch lock function or to enter the system configuration window. (However, the system does not check the password to enter the system configuration window if the user password is "0".)
- Upload the user logo using the SD card. (Not work during recording)



Caution

The logo image file has the resolution of 640x480 and the file name of GR200\_LOGO.bmp. In addition, the file shall be located in the "GR200\_LOGO" folder in the root directory of the SD card. Otherwise, the upload fails.

### [ System parameter ]

Parameter	Initial value	Configuration range
Language	English	Korean, English, Chinese (simplified/traditional)
Logo	GR200 logo	GR200 logo, user logo
Password	0000	0 ~ 9999

### ▶ Product specification

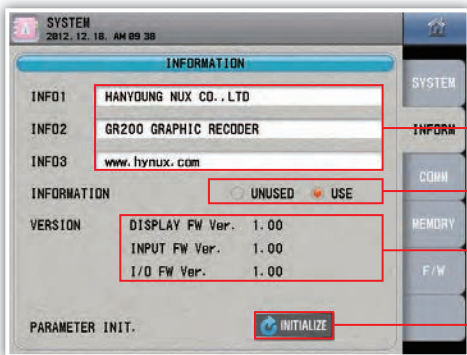

Fig. 55) Product specification screen

- Enter the information displayed for the booting.
- Check whether to display the product information for the booting.
- Display the product version information.



Caution

Initialize the parameters. Events or error history is not initialized. (Not work during recording)

### [ Product specification parameter ]

Parameter	Initial value	Configuration range
Info 1	HANYOUNG NUX CO.,LTD.	Enter the text (up to 30 characters)
Info 2	GR200 GRAPHIC RECORDER	Enter the text (up to 30 characters)
Info 3	www.hynux.com	Enter the text (up to 30 characters)
Information	Use	Unused, use

## ▶ Communication configuration

The screenshot shows the 'COMM' menu with the following settings:

- PROTOCOL:** MODBUS ASC (selected)
- BAUD RATE:** 115200 (selected)
- STOP BIT:** 1 (selected)
- DATA LENGTH:** 8 (selected)
- PARITY BIT:** NONE (selected)
- ETC ADDRESS:** 1
- ETC RESPONSE:** 0 ms

Annotations with red arrows point to these settings with the following instructions:

- Select the stop bit.
- Select the communication protocol.
- Select the communication speed.
- Select the data length.
- Enter the device number.
- Enter the response time.
- Select the parity bit.

Fig. 56) Communication configuration window

## [ Communication configuration parameter ]

Parameter	Initial value	Configuration range
Protocol	MODBUS ASC	PCLINK, PCLINK+SUM, MODBUS ASC, MODBUS RTU
Baud rate	115200	9600, 19200, 38400, 57600, 115200
Stop bit	1	1, 2
Data length	7	7, 8
Parity bit	NONE	NONE, EVEN, ODD
Address	1	1 ~ 99 (However, up to 32 including the master)
Response	0 ms	0 ~ 100 ms

## ▶ Memory

The screenshot shows the 'MEMORY' menu with the following information:

- INTERNAL MEMORY:** 17,838KB / 81,920KB
- INTERNAL MEMORY INIT.:** INITIALIZE button
- SD CARD MEMORY:** 131MB / 1,883MB
- PARAMETER UP/DOWN:** Left arrow (Download) and Right arrow (Upload) buttons

Annotations with red arrows point to these elements with the following instructions:

- Display the used / total amount of the internal memory.
- Initialize the internal memory (Not work during recording)
- Display the used / total amount of the SD card memory.
- Download the parameters to the SD card. (Not work during recording)
- Upload the parameters from the SD card. (Not work during recording)

**Caution:** Transfer the data to the SD card because the data are not restored after the initialization.

Fig. 57) Memory screen



Reference

The saved file name has the format of "GR200\_PARAMETER00.CFG". The file number increases like GR200\_PARAMETER01.CFG and GR200\_PARAMETER02 and the file is created if there is a file in the folder. The destination folder is the "GR200\_CNFG" folder in the root directory of the SD card.

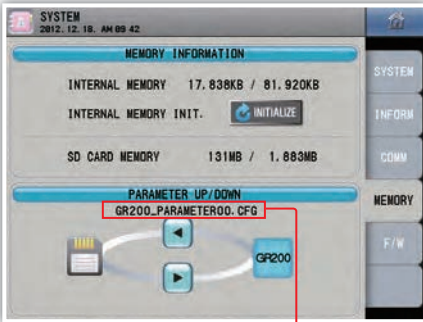

Fig. 58) Parameter download window

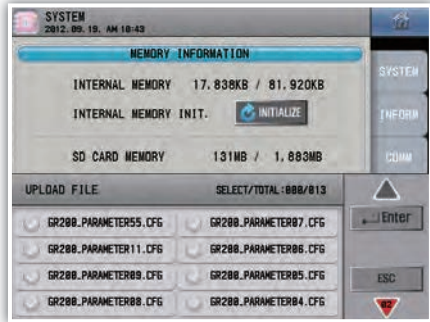

Fig. 59) Parameter upload window

Display the parameter file name created when the parameter is downloaded.

### ► Firmware upgrade

It is the screen to enter the firmware upgrade and the test mode. It is impossible to enter the screen during the operation. It is required to enter the password to enter the screen. (Initial password : 0)



Caution

- The user may not exit the screen if the user enters the screen. Please reboot the system.
- Please configure the password because the firmware upgrade required caution from the user. The initial value is "0". Please download the upgrade file from the website of "HANYOUNG NUX", Do not change the file name and take care to move the file to the GR200\_FWUP directory, the root directory of the SD file. The parameters are initialized after the firmware upgrade.

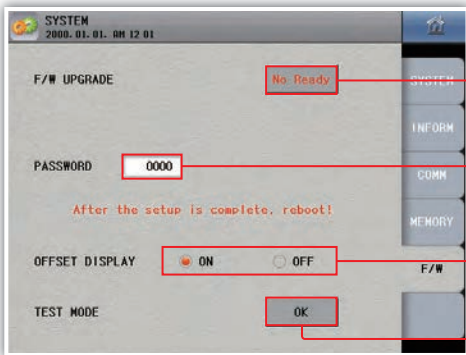

Fig. 60) F/W screen

Enter the firmware upgrade window.

Configure the password to enter the F/W window.

Picture 38) of channel calibration can be expressed or hidden.

The test mode is one for the calibration test before release.

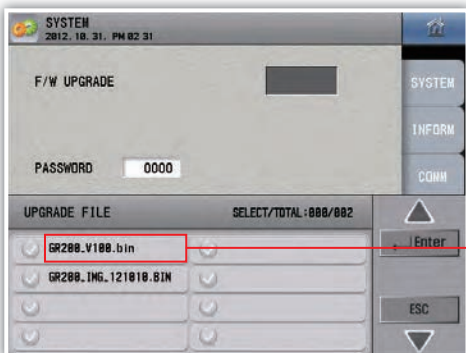

Fig. 61) Input screen for the firmware upgrade

Display the upgrade file name.

# Specifications

## 1. Input specification

[ Range configuration for the input types ]

Input type		Measurement range (°C)	Measurement range (°F)	Degree
Thermoresistor (RTD)	Pt100 Ω	Pt-0	-200 ~ 640	-300 ~ 1180
		Pt-1	-200.0 ~ 640.0	-300.0 ~ 1180.0
		Pt-2	-100.00 ~ 150.00	-300.0 ~ 1180.0
	KPt100 Ω	KPt-0	-200 ~ 500	-300 ~ 1000
		KPt-1	-200.0 ~ 500.0	-300.0 ~ 1000.0
		KPt-2	-100.00 ~ 150.00	-300.0 ~ 1000.0
Thermocouple (TC)	K	K-0	-200 ~ 1370	-300 ~ 2500
		K-1	-200.0 ~ 1370.0	-300 ~ 2500
	J	-200.0 ~ 1200.0	-300 ~ 2300	
	E	-200.0 ~ 1000.0	-300 ~ 1800	
	T	-200.0 ~ 400.0	-300 ~ 750	
	R	0.0 ~ 1700.0	-0 ~ 3100	
	B	0.0 ~ 1800.0	-0 ~ 3300	
	S	0.0 ~ 1700.0	-0 ~ 3100	
	L	-200.0 ~ 900.0	-300 ~ 1300	
	N	-200.0 ~ 1300.0	-300 ~ 2400	
	U	-200.0 ~ 400.0	-300 ~ 750	
	Wre 5-26	0.0 ~ 2300.0	-0 ~ 4200	
	PL-II	0.0 ~ 1390.0	-0 ~ 2500	
VDC	-10 - 20 mV	-10.00 ~ 20.00		±0.15 % of F.S ± 1digit ※ The current input (4 - 20 mA DC) is available when you use resistance 250 Ω (0.5 W / 0.1 %) on input terminals.
	0 - 100 mV	0.00 ~ 100.00		
	1 - 5 V	1.00 ~ 5.00		
	0 - 30 V	0.00 ~ 30.00		

(\*1) 0 ~ 400°C : ±5% of F.S ± 1digit

(\*3) -200 ~ -150°C : ±0.4% of F.S ± 1digit

(\*2) -200 ~ -150°C : ±0.2% of F.S ± 1digit

-150 ~ -100°C : ±0.2% of F.S ± 1digit

(\*4) 0 ~ 200°C : ±0.2% of F.S ± 1digit

[ Specification for the input ]

VDC	Thermocouple (TC)	K, J, E, T, R, S, B, N	IEC 584
		PL-II, Wre 5-26	ASTM E988
		U, L	DIN 43710, IEC 751
	Thermoresistor (RTD)	Pt100 Ω	DIN IEC 751
		KPt100 Ω	JIS C1604-1989 (OLD)



## 2. Hardware specification

### ▶ Power input

Power voltage	100 – 240 V AC Voltage fluctuation rate $\pm 10\%$
Power frequency	50 – 60 Hz
Power consumption	22 VA max
Maximum internal fuse ratings	250 V AC
Internal voltage	<p>Primary terminal* and secondary terminal** : Minimum 1500 VAC for 1 minute                      Primary terminal* and FG terminal : Minimum 1500 VAC for 1 minute                      Secondary terminal** and FG terminal : Minimum 1500 VAC for 1 minute                      Secondary terminal** and secondary terminal** : Minimum 500 VAC for 1 minute</p> <p>* Primary terminal : Power terminal (except the FG terminal) and the relay output terminal                      ** Secondary terminal : Sensor input terminal, contact input terminal, communication terminal</p>
Insulation resistor	20 M $\Omega$ between the power terminal and the FG terminal or 500 VDC

### ▶ Sensor input

Number of channels	2, 4, 8, 12 (Refer to the type configuration)
Input type	<p>2 thermoresistors (Pt-100, KPt-100)                      12 thermocouples (K, J, E, T, R, B, S, L, N, U, Wre 5-26, PL-II)                      4 VDC (-10 – 20 mV, 0 – 100 mV, 1 – 5V, 0 – 30 V)                      ※ The current input (4 – 20 mA DC) is available when you use resistance 250 <math>\Omega</math> (0.5 W / 0.1 %) on input terminals.</p>
Sampling period	250 ms
Current to measure the thermoresistor (RTD)	About 0.21 mA
Input resistor	Thermocouple : More than 1 M $\Omega$ , VDC : More than 1 M $\Omega$
Allowable wiring resistor	<p>Thermoresistor : Maximum 100<math>\Omega</math>/wire                      (The RTD is up to 10<math>\Omega</math>/wire for the range of -100.00 – .150.00)                      Thermocouple : Less than 200 <math>\Omega</math>                      VDC : Less than 2 k<math>\Omega</math></p>
Impact of the wiring resistor	Thermoresistor : $\pm 0.3$ $^{\circ}\text{C}/10$ $\Omega$ (The 3 lines have the same wiring resistors)
Allowable input voltage	Thermocouple : Less than $\pm 10$ V DC, VDC : Less than $\pm 33$ V DC
Degree	$\pm 0.15\%$ of F.S, $\pm 1$ digit (Except the RJC temperature error) ※ Refer to the input table
The error in the reference junction compensation (RJC)	$\pm 1.5$ $^{\circ}\text{C}$ (0 ~ 50 $^{\circ}\text{C}$ )
Sensor short detection (Burn-out)	UP-Scale for the short

### ▶ Contact input

Maximum input	4
Input method	No voltage contact input
On/Off detection resistor	Consider on less than 1 k $\Omega$ minimum and off larger than 10 k $\Omega$
Minimum detection time	0.25 second

## ▶ Alarm output

Maximum number of outputs	12
Output type	Relay output
Maximum ratings	5 A 250 V AC, 5 A 30 V DC
Recommended ratings	3 A 250 V AC, 3 A 30 V DC
Relay life	50,000 times at the maximum ratings, 100,000 times at the recommended ratings



Reference

- The sensor input terminal is insulated among the input channels. It is insulated with the relay output terminal, the contact input terminal and the communication terminal.
- The relay output terminal is not insulated among the output terminals. It is insulated with the contact input terminal and the communication terminal.
- The contact input terminal is not insulated among the input terminals. In addition, it is not insulated with the communication terminal.
- The power terminal is insulated with other input and output terminals and the internal circuit.
- The FG terminal is insulated with other input and output terminals and the internal circuit.

## 3. Display specification

Display	TFT color LCD (115.2 × 86.4 mm, resolution : 640 × 480 pixel, LED Backlight)
Backlight life	40,000 hours
Language in use	Korean, English, Chinese (simplified/traditional)

## 4. Memory specification

Save function	Internal memory – volatile memory : 900 KB – Save up to 4 hours with the interval of 1 second – Non-volatile memory : 80 MB – Save up to 15 days with the interval of 1 second External memory – SD card (2GB) : Save up to a year with the interval of 1 second ※ Support the SDHC
Save period	User configuration (1, 2, 5, 10, 20, 30, 60, 120 seconds)
Memory information	Measurement from each channel, Burn-out, DI (contact input), ALARM, relay output status

## 5. Installation environment

### ▶ Use environment

Ambient temperature	0 ~ 50 °C
Temperature change	10 °C/h or below
Ambient humidity	20 ~ 90 % RH (no condensation)
Magnetic field	400 A/m or less
Altitude	Less than 2,000 m above the sea level
Weight	About 1,32 kg

► Storage environment

Ambient temperature	-20 ~ 70 °C
Temperature change	Less than 20 °C/h
Ambient humidity	5 – 95 % RH (no condensation)

► Impact from the ambient temperature

VDC, thermocouple sensor	±0.003 % of F.S / °C
Thermoresistor sensor	±0.03 °C/°C

Before start

Installation

Operation

Screen block diagram

Operating screen

Configuration screen

Specifications



**GR200**  
Graphic Recorder

www.hynux.com

**HANYOUNG NUX**

**HANYOUNG NUX CO., LTD.**

28, Gilpa-ro 71 beon-gil, Nam-gu, Incheon, Korea

Tel : +82-32-876-4697 Fax : +82-32-876-4696 E-mail : overseas@hynux.com