

Digital watt meter

WM3

INSTRUCTION MANUAL

Thank you for purchasing HANYOUNG NUX Co.,Ltd. product. Please check whether the product you purchased is the exactly same as you ordered. Before using this product, please read instruction manual carefully.

**HANYOUNG NUX****HEAD OFFICE**1381-3, Juan-Dong, Nam-Gu Incheon, Korea
TEL : (82-32)876-4697 FAX : (82-32)876-4696

■ Safety Information

Please read safety information carefully before use and then use this product properly. Safety information described in this manual contains important contents related with safety. So please follow the instructions accordingly. Safety information is composed of DANGER, WARNING and CAUTION.



DANGER

Do not touch or contact the input terminals because they may cause electric shock.



WARNING

- This product does not contain an electric switch or fuse, so the user needs to install a separate electric switch or fuse externally. (Fuse rating : 250 V 0.5 A)
- To prevent deflection or malfunction of this product, supply proper power voltage in accordance with the rating.
- To prevent electric shock or malfunction of this product, do not supply the power until the wiring is completed.
- Since this product is not designed to explosion-protective structure, do not use it at the places which have flammable or explosive gas.
- Do not disassemble, modify, revise or repair this product. This may cause malfunction, electric shock or fire.
- Attach or detach this product while the power is off. Otherwise, it may cause malfunction or electric shock.
- If you use the product with methods other than specified by the manufacturer, there may be bodily injuries or property damages.
- Due to the danger of electric shock, use this product installed onto a panel while an electric current is applied.



CAUTION

- The contents of this manual may be changed without prior notice.
- Please check whether the product you purchased is the exactly same as you ordered.
- Please check whether the product has no damage or abnormality during delivery.
- Do not use the product at the places which have corrosive (especially noxious gas or ammonia) or flammable gas.
- Do not use this product at any place with direct vibration or impact.
- Do not use this product at any place with liquid, oil, medical substances, dust, salt or iron contents. (Pollution level 1 or 2)
- Do not polish this product by substances such as alcohol or benzene.
- Do not use this product at any place with excessive induction trouble, static electricity or magnetic noise.
- Do not use this product at any place with possible thermal accumulation due to direct sunlight or heat radiation.
- Install this product at place under 2,000 m in altitude.
- When the product gets wet, the inspection is essential because there is danger of an electric leakage or fire.
- If there is an excessive noise from power supply, it is recommended to use insulating transformer and noise filter. The noise filter must be attached to the panel grounded and wiring between the filter output side and power supply terminal should be as short as possible.
- If gauge cables are arranged too closely, the effect on noise may occur.
- Do not connect anything to the unused terminals.
- After checking polarity of terminal, connect wires to the right position.
- When this product is connected to a panel, use a circuit breaker or switch approved by IEC947-1 or IEC947-3.
- Install the circuit breaker or switch at near place for convenient use.
- Write down on a label that the operation of circuit breaker or switch disconnects the power since the devise is installed.
- For the continuous and safe use of this product, the periodic maintenance is recommended.
- Some parts of this product have limited life span, and others are changed by their usage.
- The warranty period of this product including parts is one year if this product is properly used.

■ Ratings

Power Supply	100 - 240 V a.c 50 - 60 Hz Allowable percentage of voltage difference : 85 ~ 110 %
Power consumption	6 VA
Display type	7 Segment LED display
Insulation resistance	Above 100 MΩ (500 V d.c mega standard) between external terminal and case
Max voltage durability	Above 2000 V a.c, per 1 min between external terminal and case
Max noise durability	Square wave noise due to noise simulator, pulse width 1 μs ± 1000 V
Max vibration durability	10 - 50 Hz Malfunction , double amplitude in each 0.5 mm X, Y, Z direction for 1 hour 10 - 50 Hz Durability , double amplitude in each 0.75 mm X, Y, Z direction for 2 hours
Max shock durability	100 % Malfunction each X, Y, Z direction for 3 times 300 % Durability each X, Y, Z direction for 2 times
Ambient temperature	- 10 ~ 55 °C (No freezing allowed)
Ambient humidity	Relative humidity 35 ~ 85 % R.H
Ambient environment	Corrosiveness gas not allowed
storage ambient temperature	-20 ~ 65 % °C (No freezing allowed)
Relay life	Mechanically : 20,000,000 ps Min. Electrically : 100,000 ps Min.
Weight	Approximately 300g

■ Function

Measurement type	Cycle measuring type, $\cos \phi = \text{LEAD } 0.8 - 1 - \text{LAG } 0.8$
Display cycle	Min. : 0.1 second, Max. 2 second
Displayable number of digits	-1999 ~ 9999 (4 digits standard)
Measuring list	Power consumption
Input range	0 - 240 V a.c 50 - 60 Hz
Function of decimal point	Selection due to internal parameter
Function of scaling	Function of displaying temporal numerical values which is converted from measured (input)
Hold function	Automatic max and min Peak value detection hold and external hold
Control	Displaying value hold
Other functions	<ul style="list-style-type: none"> Remote local switching (communication output type) • Display max/min value by front key Function of handling average value and delaying displaying cycle Changing comparative output setting • Set value changing protective function
Output type	<ul style="list-style-type: none"> Relay contact output Transistor output (NPN, PNP) Current output (4 - 20 mA) Communication output (RS485)

■ Suffix code

Model Name	Suffix code	Description
WM	<input type="checkbox"/> <input type="checkbox"/> <input type="checkbox"/> <input type="checkbox"/>	Digital Wattmeter
External dimension	3	External dimension (96 mm X 48 mm)
Type of phase	1	Single phase 2 W
Measurement input specification	01(※)	xxx : 5 A (A general C.T uses) Current transform ratio setup (C.T excluded)
	02(※)	xxx : 1 A (A general C.T uses) Current transform ratio setup (C.T excluded)
	03	0 - 2.5 A (H-1W C.T uses) 0 - 500.0 W Max.(C.T included)
	04	0 - 5 A (H-1W C.T uses) 0 - 1100 W Max.(C.T included)
	05	0 - 10 A (H-1W C.T uses) 0 - 2200 W Max.(C.T included)
	06	0 - 15 A (H-1W C.T uses) 0 - 3300 W Max.(C.T included)
	07	0 - 30 A (H-1W C.T uses) 0 - 6600 W Max.(C.T included)
	08	0 - 50 A (H-1W C.T uses) 0 - 11.00 kW Max.(C.T included)
	09	0 - 80 A (H-1W C.T uses) 0 - 17.60 kW Max.(C.T included)
	10	0 - 100 A (H-1W C.T uses) 0 - 22.00 kW Max.(C.T included)
	11	0 - 150 A (H-1W C.T uses) 0 - 33.00 kW Max.(C.T included)
	12	0 - 200 A (H-1W C.T uses) 0 - 44.00 kW Max.(C.T included)
output specification (option)	N	only for display
	0	Relay (HI, GO, LO) + Current output (4 - 20 mA)
	1	Relay (HI, GO, LO)
	2	NPN TR (HI, GO, LO) + Current output (4 - 20 mA)
	3	PNP TR (HI, GO, LO) + Current output (4 - 20 mA)
	4	NPN TR (HI, GO, LO) + RS485 Output
5	PNP TR (HI, GO, LO) + RS485 Output	

C.T (Current Transformers)

※ Spec 01 and 02 use general current transformer and users must set current transform ratio (Refer to setting method of current transformer)

Spec 03 ~ 12 are accurate measuring wattmeter which uses H series C.T of accuracy 0.2 %.

Caution spec of 03 ~ 12 cannot use general current transformer and it is unnecessary to set current transform ratio.

- Type of measuring spec is single phase 2 lines and when current transformer is 200 A : 5 A, then please purchase WM2-101 and use it. (If current transformer is 200A:1A then please use WM3-101)

- Initial current transformer setting for spec 01 and 02 is set with 100 A

- Output spec 0 ~ 5 are option

- PV (output displaying value)

- RS485 output spec is coming soon

■ Connection (wiring)

● WM3 -1-□□□□

Current transformer used (use specific current transformer or general current transformer)

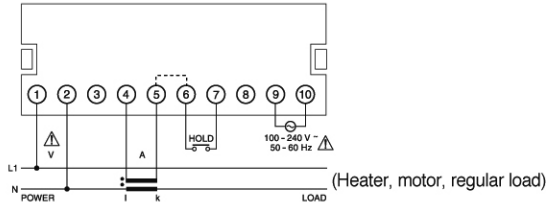

● WM3 -101-□

Current transformer not used (When measuring below 5A, wire directly : WM3 - 101 - X)
(When measuring below 1A, wire directly : WM3 - 102 - X)

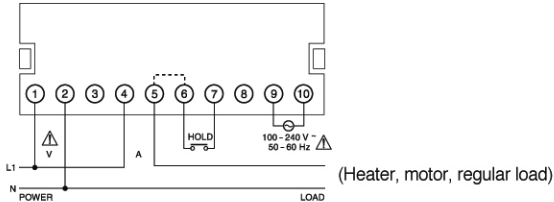

Cautious cannot wire directly within product suffix code number 03 ~ 12

■ Sub output

● WM3 -1-□□□-0 (Relay output, 4 - 20 mA current output)

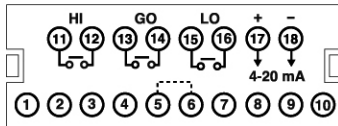

● WM3 -1-□□□-1 (Relay output)

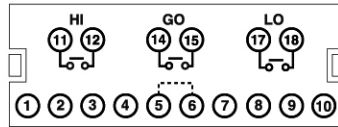

● RS-485 output Hirose20P Flot connector

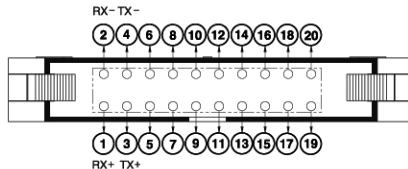

● Current output Hirose20P Flot connector Load resistance less than 600 MΩ

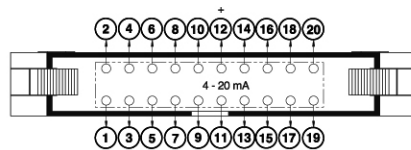

※ In case of using sub output, HIROSE will be excluded and users must purchase HIF3BA-20DA-2.54R and operate.

■ Main output

● TR [PNP] output HIROSE20P Flot connector

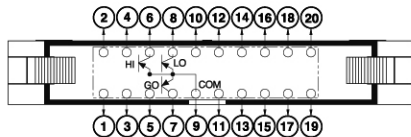

● TR [NPN] output HIROSE20P Flot connector

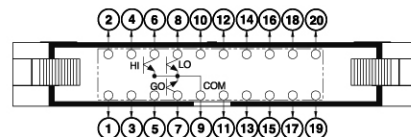

■ Parameter set up method using current transformer (C.T) ratio

Current Transformers		Parameter1 setting value	Calculated value (power factor=1) Input voltage(V) x input current(I)
Primary	Secondary	C_{tr}	
5 A	5 A or 1 A	5	220 V x 5 A = 1100 W
10 A		10	220 V x 10 A = 2200 W
15 A		15	220 V x 15 A = 3300 W
20 A		20	220 V x 20 A = 4400 W
25 A		25	220 V x 25 A = 5500 W
30 A		30	220 V x 30 A = 6600 W
40 A		40	220 V x 40 A = 8800 W
50 A		50	220 V x 50 A = 11.00 kW
60 A		60	220 V x 60 A = 13.20 kW
75 A		75	220 V x 75 A = 16.50 kW
100 A		100	220 V x 100 A = 22.00 kW
120 A		120	220 V x 120 A = 26.40 kW
150 A		150	220 V x 150 A = 33.00 kW
200 A		200	220 V x 200 A = 44.00 kW
240 A		240	220 V x 240 A = 52.80 kW
250 A	250	220 V x 250 A = 55.00 kW	
300 A	300	220 V x 300 A = 66.00 kW	
400 A	400	220 V x 400 A = 88.00 kW	
500 A	500	220 V x 500 A = 110.0 kW	
600 A	600	220 V x 600 A = 132.0 kW	
750 A	750	220 V x 750 A = 165.0 kW	
800 A	800	220 V x 800 A = 176.0 kW	
1000 A	1000	220 V x 1000 A = 220.0 kW	
1200 A	1200	220 V x 1200 A = 264.0 kW	
1500 A	1500	220 V x 1500 A = 330.0 kW	

※ Does not apply to specific current transformer that uses spec number 03 ~ 12

■ Output specification

PARAMETER	MODE	WM3
PARAMETER 1	C_{tr}	100
	2Rdc	10
	3SCH	2
	4SCL	2
	5dPP	0000
	6PdH	oFF
	7LoC	oFF
PARAMETER 2	8Rdr	00
	9bPS	96%
	HHP%	-
	LLP%	-
	HSEt	5000
	LSEt	2000
	P5o%	oFF
HYS%	01	

※ Rdr and bPS may not be displayed depends on spec

※ C_{tr} and dPP may vary depends on spec

■ parameter 1 terminology explanation

C_{tr} : Set primary current of current transformers

2Rdc : It is hard to measure accurately when measured input values are changed too frequently. In this case, it is possible to display average value by changing set value of ampere turn. For example, setting 2 in parameter will measure values 2 consecutive times. After that, calculate average of those values and display. Default value = 10

3SCH : Convert measured (input) high value to numerical values and display. SCALE FUNCTION high set value

4SCL : Convert measured (input) low value to numerical values and display. SCALE FUNCTION low set value.

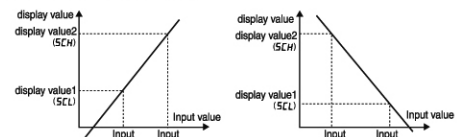

Built in scale function which can convert input signal to certain numerical value and display. Can adjust increase mark, reverse mark and + ~ - mark freely. (Refer to scale set method)

5dPP : Set position of decimal point. Default value = 000.0
 (※ Position of **dPP** decimal points may change depends on specification)

6PdH : Used when detecting PEAK value or external hold (E-Hd) and initial set value is set as OFF. For example, if PdH parameter is set as H-Hd (max hold value) and currently input value is smaller than max value, then it displays maximum value among input values. In opposite case, if currently input value is bigger than maximum value then it does auto hold and displays current input value. L-Hd (minimum hold value) works same as H-Hd.

7LoC : Used when locking parameter function of panel meter. For example, if Loc parameter is set as ON, then it is impossible to set all parameters.

8Adr : Set communication address. Default value = 00

9bPS : Set Baud Rate. Default value = 9600 bps

Parameter 1

Display	Description	Initial value	Setting range	Reference	
LCtr	Current Transformer Ratio	100	Max set value : 1500 Min set value : 2	Set primary current in current transformer	
2Rdc	Averag delay count	1	Max set value : 10 Min set value : 1	Set number of turns in order to measure average value of input values	
35CH	High Scale	2	Max set value : 9999 Min set value : -1999	When want to display converted numerical value, set the low value among selected values.	
45CL	Low Scale	2	Max set value : 9999 Min set value : -1999	When want to display converted numerical value, set the low value among selected values.	
5dPP	Dot Point	0000		Set the position of decimal point	
6PdH	Peak auto detect Hold	OFF	OFF H-Hd L-Hd E-Hd	Set auto holding when detecting Peak value. Use external old (E-Hd)	
7LoC	Lock	OFF	ON OFF	Set lock function of panel meter	
8Adr	Address	00	Max set value : 99 Min set value : 00	Set communication Address and Baud Rate (BPS). ※ Displayed only with RS485 communication output	
9bPS	bps	960	120		1200
			240		2400
			480		4800
			960		9600
			1920	19200	

Parameter 2 terminology explanation

- HHPV** : Display max value among measured values of inputs
- LLPV** : Display min value among measured values of inputs
- HSEt** : Set a value of High Comparative Output. Default = 5000
- LSEt** : Set a value of Low Comparative Output. Default = 2000
- PSot** : Select an operating mode of Comparative Output. Default = OFF
- HYS** : Set hysteresis of Comparative Output. Default = 01

Parameter 2

Display	Description	Initial value	Setting range	Reference
HHPV	High Peak Display	-	Impossible to set	Display max value among present input values
LLPV	Low Peak Display	-	Impossible to set	Display min value among present input values
HSEt	Output High Set	5000	Max set value : +9999 Min set value : -1999	Set a standard value of High Comparative Output
LSEt	Output Low Set	2000	Max set value : +9999 Min set value : -1999	Set a standard value of Low Comparative Output
PSot	Output Type Select	OFF	LL(LL.ot) HH(HH.ot) LH(LH.ot) HL(HL.ot) IL(IL.ot)	Set a mode of Comparative Output Operation
HYS	HYSteris	01	Max set value : 99 Min set value : 00	Set HYSteris of Comparative Output

Comparative output mode (PSot)

Operation mode	Output operation	Operation description
OFF		No output operation
LLot		If $PDV \leq LSEt$ then Low output on If $PDV \geq LSEt$ then Go output on
HHot		If $PDV \geq HSEt$ then Low output on If $PDV \leq HSEt$ then Go output on
LHot		If $PDV \leq LSEt$ then low output on If $PDV \geq HSEt$ then high output on If $LSEt \leq PDV \leq HSEt$ then go output on
HLot		If $PDV \leq LSEt$ then low output on If $PDV \geq HSEt$ then high output on If $PDV \geq LSEt \leq HSEt$ then high then go output on
ILot		It is the same as the way of LLot operation but low output will not operate if it is below the initial LSEt . It will operate at the next setting value of HSEt .

Parameter setting method

Parameter 1 (* - more than 2 seconds)

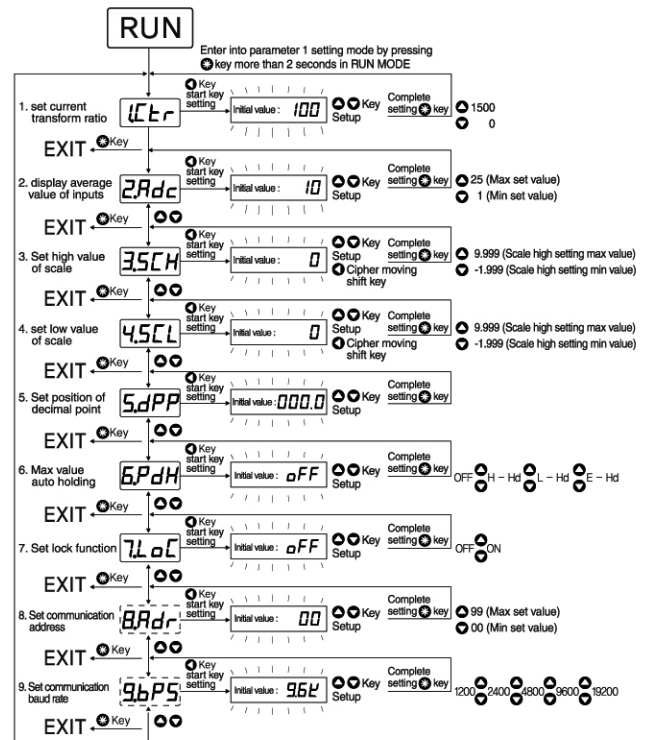

Parameter 2 (press * key more than 2 seconds)

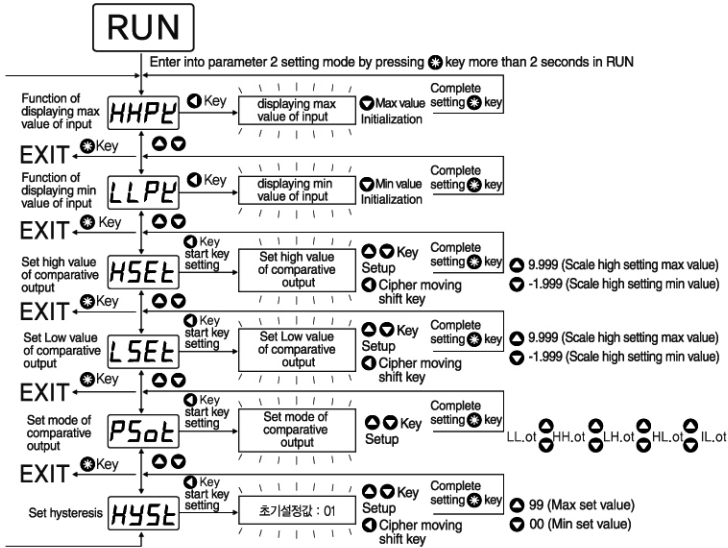

Lock key (press * key for more than 2 seconds)

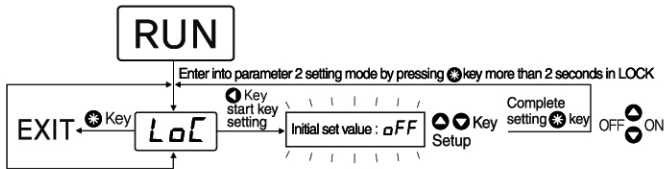

lock key (press * key for more than 2 seconds)

- Pressing * key in RUN MODE [parameter1 (more than 2 sec), parameter 2 (less than 2 sec)] will enter into setting mode of parameter.
- Able to select parameter by pressing ▲ and ▼ key and within selected parameter, parameter and set value will repeatedly flicker.
- Able to change set value by pressing ◀ key and set value will start to flicker. (when the set value is 0, then only 0th digit integer will flicker)



When the set value is 0, then only 0th digit integer will flicker

To change 100th digit value, press ◀ key 3 times. Each time when users press the key, position of the digit will move to left side and selected position of value will flicker.

Once setting is completed, return to parameter mode by pressing * key. Here, make parameter and set value to flicker repeatedly. Press * key to return to RUN mode.

Defaulting set values

While pressing ▲ key, press the key * → ◀ → ▼ then LSEL will be displayed. At that time, press up key again then all the set values will be defaulted. (if LoC function is ON, it is impossible to default)

Error display code

- HH-** : This will be displayed when it is higher than Max Range 9999 (for 4 digits model) or a negative number is appeared in Normal mode. Normal mode: SCH 0 or SCL 0
- Over** : This will be displayed when a measured input value exceeded max input range.
- HLer** : Error message will be displayed when a setting value of High Comparative Output is less than that of Low Comparative Output

Scale setting method

Current transform ratio of special specification setting method

Ex) when ratio of current transformer is 350 A : 5A and same parameter 1 setting method current transformer ratio is 350A : 5A then calculation of electric power is as follows.
 $220\text{ V} \times 350\text{ A} = 77.00\text{ kW}$

- Enter into parameter 1 mode by pressing * key more than 2 seconds
- Move to SCH mode by pressing ▲ and ▼ key (2. SCH and 0 will be displayed repeatedly)
- Pressing * key will make displayed value to flicker (cipher moving key: ◀)
- Set to 7700 by pressing ◀ and ▼ key
- When setting up is completed, press * key to return to main screen

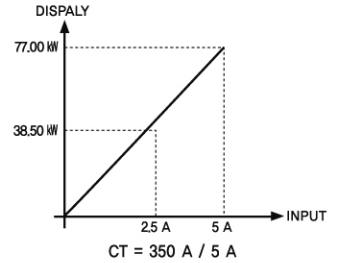

Parameter	Parameter 1	
	SCH	Decimal points
Set Value	7700	00.00

Transfer function (sub output)

- RS485 communication
 - Set address from 00 to 99 to communicate and it is possible to transfer by selecting and
 - Setting baud rate of series transfer.
 - Select and set transfer speed (BPS) : (1200, 2400, 4800, 9600, 19200)
 - Current output
 - Yield 4 - 20 mA d.c output regarding currently displayed value (resolving power 12000)
 - PNP output (open collector output, less than 12 - 24 V d.c 50 mA)
 - NPN output (open collector output, less than 12 - 24 V d.c 50 mA)
 - Relay output (less than 250 V a.c 5 A) 1a x 3
- ※Cautious WM3 is electric power meter (cycle measuring type). In case of input is less than 2 % of max input, then measurement may not occur or displaying cycle may slow down (max 2 seconds)

Dimensions & Panel Cutout

[Unit : mm]

