

Multi Pulsemeter

RP series

INSTRUCTION MANUAL

Thank you for purchasing HANYOUNG NUX CO.,Ltd. Product. Please check whether the product you purchased is the exactly same as you ordered. Before using product, please read instruction manual carefully.



HANYOUNGNUX CO.,LTD

1381-3, Juan-Dong, Nam-Gu Incheon, Korea

HEAD OFFICE

TEL: (+82-32)876-4697 FAX: (+82-32)876-4696

Safety Information

Alerts declared in the manual are classified to Danger, Warning and Caution by their criticality

DANGER	DANGER indicates an imminently hazardous situation which, if not avoided, will result in death or serious injury
WARNING	WARNING indicates a potentially hazardous situation which, if not avoided, could result in death or serious injury
CAUTION	CAUTION indicates a potentially hazardous situation which, if not avoided, may result in minor or moderate injury

Danger

Do not touch or contact the input/output terminals because they may cause electric shock.

Warning

- This product does not contain an electric switch or fuse, so the user needs to install a separate electric switch or fuse externally. (Fuse rating : 250 V 0.5 A)
- To prevent deflection or malfunction of this product, supply proper power voltage in accordance with the rating.
- To prevent electric shock or devise malfunction of this product, do not supply the power until the wiring is completed.
- Do not decompose, modify, revise or repair this product. This may cause malfunction, electric shock or fire.
- Reassemble this product while the power is off. Otherwise, it may cause malfunction or electric shock.
- If you use the product with methods other than specified by the manufacturer, there may be bodily injuries or property damages.
- Due to the danger of electric shock, use this product installed onto a panel while an electric current is applied.

Caution

- The contents of this manual may be changed without prior notification.
- Before using the product you have purchased, check to make sure that it is

exactly what you ordered.

- If you use the product with methods other than specified by the manufacturer, there may be bodily injuries or property damages.
- Check to make sure that there is no damage or abnormality of the product during delivery.
- Do not use this product at any place with corrosive (especially noxious gas or ammonia) or flammable gas.
- Do not use this product at any place with direct vibration or impact.
- Do not use this product at any place with liquid, oil, medical substances, dust, salt or iron contents. (Pollution level 1 or 2)
- Do not polish this product with substances such as alcohol or benzene.
- Do not use this product at any place with excessive induction trouble, static electricity or magnetic noise.
- Do not use this product at any place with possible thermal accumulation due to direct sunlight or heat radiation.
- Install this product at place under 2,000 m in altitude.
- When the product gets wet, the inspection is essential because there is danger of an electric leakage or fire.
- If there is excessive noise from the power supply, using insulating transformer and noise filter is recommended.
- The noise filter must be attached to a panel grounded, and the wire between the filter output side and power supply terminal must be as short as possible.
- If gauge cables are twisted closely, the effect on noise may occur.
- Do not connect anything to the unused terminals.
- After checking polarity of terminal, connect wires at the correct position.
- When this product is connected to a panel, use a circuit breaker or switch approved with IEC847-1 or IEC947-3.
- Install the circuit breaker or switch at near place for convenient use.
- For the continuous and safe use of this product, the periodical maintenance is recommended.
- Some parts of this product have limited life span, and others are changed by their usage.
- The warranty period for this product including parts is one year if this product is properly used.

Specifications

Model	RP1	RP3	RP4	RP6	RP7	
Power supply	100 - 240 V a.c 50 - 60 Hz					
voltage	a.c	-				
	d.c	24 - 60 V d.c / a.c				
Voltage fluctuation	±10 % of Power supply voltage					
Power consumption (Approximately)	a.c	10 VA	9.5 VA	12 VA	12 VA	9.5 VA
	d.c	-	5 W	6 W	5 W	5 W
Voltage for sensor	12 V d.c ±10 % 120 mA Max.					
Measurement accuracy	<ul style="list-style-type: none"> • Mode F1, F2, F3, F4, F5 : ± 0.02 % rdg ±1 dig • Mode F6 : ± 0.1 % rdg ±1 digit 					
Measurement range	<ul style="list-style-type: none"> • Mode F1 : 0.0003 ~ 10 KHz • Mode F2 : 0.003 ~ 1000 Hz • Mode F3, F4, F5, F6 : 0.001 s ~ 3,200 s • Mode F7, F8, F9 : 0 - 4×10⁹ Count 					
Input signal	Non Contact Input : 10 KHz Max. (ON voltage : 4.5 V - 24 V, OFF voltage : 0 - 1.0 V) Contact Input : 30 Hz Max. (12 V d.c Able to switch the current of 2 mA sufficiently)					
Displayable digits max	4 digits 1 stage (0~9999)		5 digits 1 stage (0~99999)			
Display method	7 Segment					
Font size (mm)	Width	6.3	8.3	4.6	7.6	7.6
	Length	10	14	8	13.8	13.8
Display cycle	0.05, 0.5, 1, 2, 4, 8 sec					
Operation mode	F1 : Revolution/Frequency/Velocity, F2 : Moving velocity, F3 : Cycle F4 : Passing time, F5 : Time lag, F6 : Time width, F7 : Pulse width, F8 : Pulse interval, F9 : Addition counter					
Prescale	0.001 × 10 ⁻⁹ ~ 9.999 × 10 ⁹		0.0001 × 10 ⁻⁹ ~ 9.9999 × 10 ⁹			

Model	RP1	RP3	RP4	RP6	RP7
Other functions	<ul style="list-style-type: none"> • Auto Zero Time setting function • Time Unit Selection function • Parameter Lock function • Electricity Failure Compensation function (Applicable only to F9) • Start Compensation Timer function • Display cycle setting function • 10 steps memory for max, min, Peak function (max : 4 steps memory, average value memory, min : 4 steps memory, average value memory) • Comparative Output function (HH, H, GO, L, LL) : RP1, RP4, RP6 exception • Current Output Range Selection function (Applicable only to current output type) : RP1, RP4 exception 				
Output	<ul style="list-style-type: none"> • Relay high limit output(H) • Relay output (HH, H, GO, L, LL) : RP1, RP4, RP6 exception • Transistor output (NPN open collector output : comparative alarm output) : RP1, RP4 exception • PV retransmission output (4 - 20 mA d.c) : RP1, RP4 exception • Relay output (H, GO, L) : RP1, RP4 exception 				
Insulation Resistance	More than 10 M Ω (at 500V d.c) - Between electrically chargeable part and non-electrically chargeable part				
Dielectric Strength	2000V a.c 60 Hz for 1 minute (Between AC power terminal and case, between AC terminal and measurement input terminal)				
Noise Resistance	Square-shaped wave noise by noise simulator (Pulse width 1 μ s ±2000 V)				
Vibration Resistance	Durability : 10 - 55 Hz double amplitude width 0.75 mm X · Y · Z each direction for 2 hours Malfunction : 10 - 55 Hz double amplitude width 0.5 mm X · Y · Z each direction for 10 minutes				
Shock Resistance	Durability : 300 % (30 G) X · Y · Z each direction 3 times Malfunction : 100 % (10 G) X · Y · Z each direction 3 times				
Operating ambient temperature	-10 ~ 50 °C (Without condensation)				
Storage temperature	-20 ~ 60 °C (Without condensation)				
Operating ambient humidity	35 ~ 85 % R.H.				
Weight(approximately)	115 g	230 g	115 g	160 g	225 g

Suffix Code

Model Name	Suffix Code	Description	
R P	<input type="checkbox"/> <input type="checkbox"/> <input type="checkbox"/> <input type="checkbox"/>	Multi Pulse Meter	
Size	1	(W)48 × (H)24	
	3	(W)96 × (H)48	
	4	(W)48 × (H)48	
	6	(W)72 × (H)36	
	7	(W)72 × (H)72	
Displayable Digits	4	4 digits 1 stage (0 - 9999) * applicable to RP1	
	5	5 digits 1 stage (0 - 99999)	
Power Supply	A	100 - 240 V a.c 50 - 60 Hz	
	D	24 - 60 V d.c / a.c * Exception : RP1	
Output Specification	RP1	N	Display Only
		1	Relay 1 stage output (H : High limit output)
	RP3	N	Display Only
		1	Relay 3 stages output (H, GO, L)
		2	Relay 5 stages output (HH, H, GO, L, LL)
	RP4	N	Display Only
		1	Relay 1 stage output (H : High limit output)
	RP6	N	Display Only
		1	Relay 3 stages output (H, GO, L)
	RP7	N	Display Only
		1	Relay 3 stages output (H, GO, L)
		2	Relay 5 stages output (HH, H, GO, L, LL)
		3	NPN Open Collector 5 stages output, 4-20 mA d.c.(Retransmission output)
		5	NPN Open Collector 5 stages output, 4-20 mA d.c.(Retransmission output)

Non Contact Output

- Rated load power consumption : 500 mW
- Output type : NPN Open Collector
- Load Voltage : 12 - 24 V d.c

PV Retransmission Output(4 - 20 mA d.c)

- Use : Transmit measured value to external equipment
- Function : Measured value which is measured within the selected range out of High output(PV-H) and Low output(PV-L) will be transformed to 4 - 20 mA d.c and it will be transmitted to external equipment.
- Setting range of High and Low output
 - High setting range (PV-H) : From minimum to maximum value within measuring range.
 - Low setting range (PV-L) : From maximum to minimum value within measuring range.
 (Notice : PV-H must be bigger than PV-L at least 1)
- Load resistance : 600 Ω max
- Resolution : 10,000

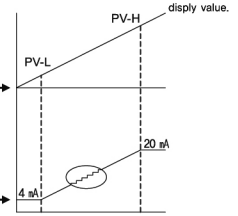

When selecting PV-L, PV-H in the desired range, 4 - 20 mA d.c output will be done in the selected range.

Resolution from PV-L to PV-H is set to 10,000. The setting value (The difference PV-H and PV-L) is smaller than resolution, error ratio will be going down.

Operation Mode

Mode F 1 : Revolution(rpm) / Frequency(Hz) / Velocity (m/s)

- Revolution (rpm) = $f \times \alpha$ ($\alpha = 60$, default value)
 - Frequency(Hz) = $f \times \alpha$ ($\alpha = 1$, setting value)
 - Velocity(m/s) = $f \times \alpha$ ($\alpha = 1 \times L$)
 - $L = \pi \times D$
 - $\ell = L / N$
 - $f = 1 / T$
- ※ α : prescale value
 ※ N : number of form per 1 revolution
 ※ D : diameter of roller
 ※ ℓ : moving distance when one pulse comes in
 ※ π : 3.141592
 ※ f : number of input pulse per second
 ※ L : circumference of roller
 ※ T : Time

Example of practical application

Prescale example

Display value	Unit	Prescale value(α)
Revolution	rps	1
	rpm	60(default value)
Frequency	Hz	1
	KHz	0.001
	mm/s	1000 ℓ
Velocity	cm/s	100 ℓ
	m/s	1 ℓ
	m/min	60 ℓ
	km/hour	3.6 ℓ

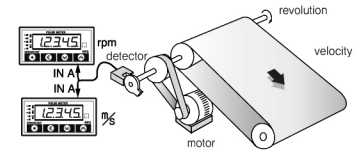

※ Default setting : rpm

Input Specification

Input Specification

If the half-period of input frequency is more than 50us pulse, it can be detected steadily.

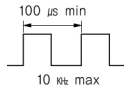

Input Type Selection (Selection of Input Sensor)

- $\alpha P \alpha \alpha \alpha$: NPN Normal Open
- $\alpha P \alpha \alpha \alpha$: NPN Normal Close
- $P \alpha P \alpha \alpha$: PNP Normal Open
- $P \alpha P \alpha \alpha$: PNP Normal Close

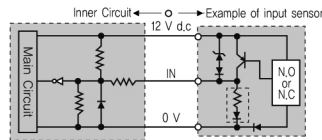
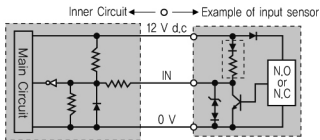

Example of input contact

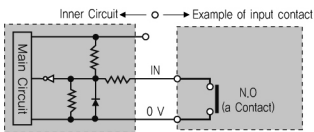

Cautions when setting sensor

- Measured value is not available when sensor is not selected correctly. So please check the sensor type before connecting sensor.
- Example of sensor type selection
 - $\alpha P \alpha \alpha \alpha$ - Normally open, when closed due to the operation -> (NPN N.O)
 - $\alpha P \alpha \alpha \alpha$ - Normally close, when opened due to the operation -> (NPN N.C)

Output Specification

Contact Output

- Contact Capacity : 5 A 250 V a.c, 5 A 30 V d.c
- Electrical life - Open & Close under 250 V a.c 3 A(30 V d.c 3 A)100 thousand times
Open & Close under 250 V a.c 5 A(30 V d.c 5 A)50 thousand times
Speed of open and close : based on 20 times per minute.
- Mechanical life : 20 million times

Mode F 2 : Moving velocity(m/s)

It is a mode for measuring moving velocity. Sensor must be connected on Input A and B because it is a mode for measuring velocity from sensor input A to B.

- velocity(m/s) = $f \times \alpha$ ($\alpha = L$)
- $f = 1 / T$
- ※ α : prescale value
- ※ L : distance from sensor A to B
- ※ f : frequency
- ※ T : measured time from sensor in A to sensor in B

Example of practical application

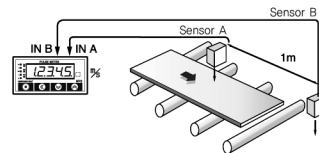

• Default setting : m/s

Prescale example

display value	Unit	Prescale value(α)
velocity	mm/s	1000
	cm/s	100
	m/s	1(default value)
	m/min	60
	km/hour	3.6

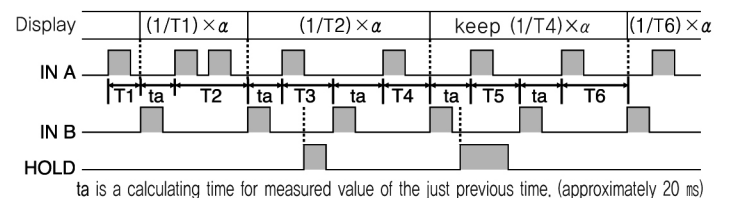

Mode F3 : Cycle (s)

It is a mode for measuring cycle(time T) of sensor input A (IN A).
Cycle shows the time from just before input to current input.

- Cycle(s) = T • T = 1 / f
- ※ Prescale is not available in this mode.

※ f = Frequency
※ T = Time

● Example of practical application

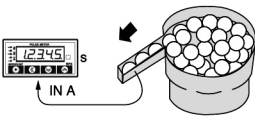

Display value	Decimal system	Sexagesimal system	
Cycle	<u>S</u> ddd	9.9999 s	<u>S</u> ddd 59.999 s
	<u>SS</u> ddd	99.999 s	<u>nn</u> SSd 59 m 59.9 s
	<u>SSS</u> dd	999.99 s	<u>nnn</u> SS 999 m 59 s
	<u>SSSS</u> d	9999.9 s	<u>Hnn</u> SS 9 h 59 m 59 s
	<u>SSSSS</u>	99999 s	<u>HHH</u> nn 999 h 59 m

※ Underlined figures are not shown on RP1(4 digits) model.

※ Default setting : 9.9999 s

※ It is possible to set output unit in the $\boxed{\text{E} \text{ N} \text{ E}}$ of PS Group($\boxed{\text{P} \text{ S} \text{ G} \text{ r} \text{ P}}$)

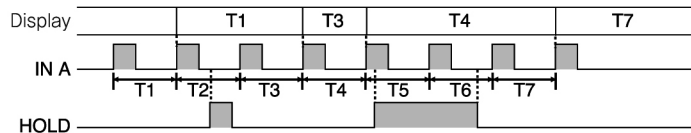

Mode F4 : Passing Time(s)

It is a mode for measuring passing time of processing operation.

- Passing Time(s) = T x α
- T = 1 / f • $\alpha = \ell / L$
- L = $\frac{\pi D(\text{circumference of the roller})}{N(\text{pulse per 1 revolution of the encoder})}$

※ D : diameter of roller
※ π : 3.141592
※ L : moving distance per 1 pulse
※ ℓ : length of processing operation
※ f : Frequency
※ T : Time

● Example of practical application

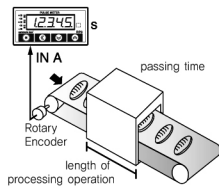

Display value	Decimal system	Sexagesimal system	
Cycle	<u>S</u> ddd	9.9999 s	<u>S</u> ddd 59.999 s
	<u>SS</u> ddd	99.999 s	<u>nn</u> SSd 59 m 59.9 s
	<u>SSS</u> dd	999.99 s	<u>nnn</u> SS 999 m 59 s
	<u>SSSS</u> d	9999.9 s	<u>Hnn</u> SS 9 h 59 m 59 s
	<u>SSSSS</u>	99999 s	<u>HHH</u> nn 999 h 59 m

※ Underlined figures are not shown on RP1(4 digits) model.

※ Default setting : 9.9999 s

※ It is possible to set output unit in the $\boxed{\text{E} \text{ N} \text{ E}}$ of PS Group($\boxed{\text{P} \text{ S} \text{ G} \text{ r} \text{ P}}$)

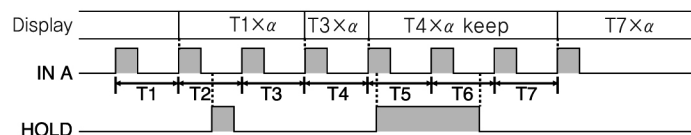

Mode F5 : Time Lag(s)

It is a mode for measuring time from sensor input A(IN A) ON to sensor input B(IN B) ON. Sensor must be connected on Input A and B because it is a mode for measuring time lag from sensor input A to B.

- time lag(s) = T ※ T : measured time from sensor A to sensor B
- ※ Prescale is not available in this mode

● Example of practical application

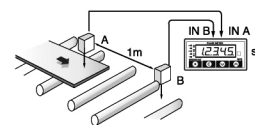

Display value	Decimal system	Sexagesimal system	
Cycle	<u>S</u> ddd	9.9999 s	<u>S</u> ddd 59.999 s
	<u>SS</u> ddd	99.999 s	<u>nn</u> SSd 59 m 59.9 s
	<u>SSS</u> dd	999.99 s	<u>nnn</u> SS 999 m 59 s
	<u>SSSS</u> d	9999.9 s	<u>Hnn</u> SS 9 h 59 m 59 s
	<u>SSSSS</u>	99999 s	<u>HHH</u> nn 999 h 59 m

※ Underlined figures are not shown on RP1(4 digits) model.

※ Default setting : 9.9999 s

※ It is possible to set output unit in the $\boxed{\text{E} \text{ N} \text{ E}}$ of PS Group($\boxed{\text{P} \text{ S} \text{ G} \text{ r} \text{ P}}$)

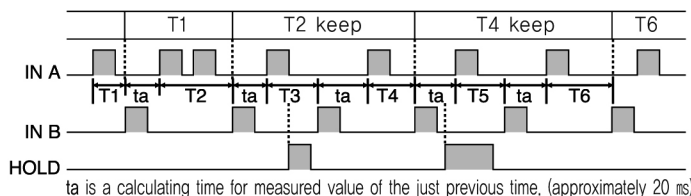

Mode F6 : Time Width(s)

It is a mode for displaying after measuring time of sensor input A(IN A) ON.

- Time Width(s) = T
- ※ Prescale is not available in this mode.

※ T : sensor A ON time

● Example of practical application

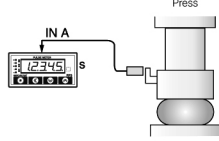

Display value	Decimal system	Sexagesimal system	
Cycle	<u>S</u> ddd	9.9999 s	<u>S</u> ddd 59.999 s
	<u>SS</u> ddd	99.999 s	<u>nn</u> SSd 59 m 59.9 s
	<u>SSS</u> dd	999.99 s	<u>nnn</u> SS 999 m 59 s
	<u>SSSS</u> d	9999.9 s	<u>Hnn</u> SS 9 h 59 m 59 s
	<u>SSSSS</u>	99999 s	<u>HHH</u> nn 999 h 59 m

※ Underlined figures are not shown on RP1(4 digits) model.

※ Default setting : 9.9999 s

※ It is possible to set output unit in the $\boxed{\text{E} \text{ N} \text{ E}}$ of PS Group($\boxed{\text{P} \text{ S} \text{ G} \text{ r} \text{ P}}$)

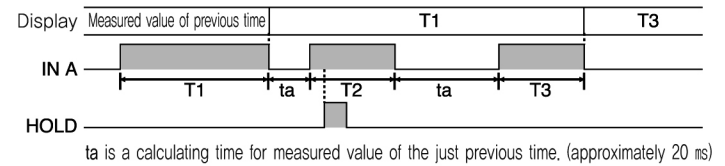

Mode F7 : pulse width (m)

During the sensor input B (IN B) is being ON, it counts the pulse number of input A (IN A) and when input B becomes OFF, it displays the counted value.

- Pulse count(EA) = P x α
- Pulse width(m) = P x ℓ
- L = π x D
- $\ell = L / N$

※ π : 3.141592 ※ D : Diameter of roller
 ※ α : Prescale value ※ L : Circumference of the roller
 ※ ℓ : Moved distance per 1 pulse input
 ※ N : Number of pulse generation from the encoder when roller rotates 1 revolution
 ※ P : Number of Pulse inputted to IN A when sensor input B (IN B) is being ON

● Example of practical application

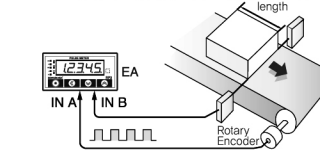

• Prescale example

Display value	Unit	Prescale value(α)
Pulse width	mm	1000 ℓ
	cm	100 ℓ
	m	1 ℓ
	EA	1(default value)

• Default setting : EA

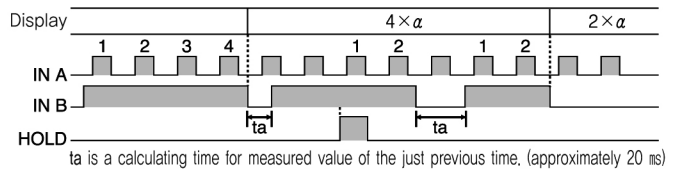

Mode F8 : pulse gap counting (EA)

Calculate the pulse number of input A (IN A) at the point where the sensor input B (IN B) becomes ON and if the input B (IN B) becomes ON one again, it will display the calculated value that has been calculated until now.

- Pulse gap count(EA) = P x α
- Pulse gap(m) = P x ℓ
- L = π x D
- $\ell = L / N$

※ α : prescale value ※ P : Number of Pulse inputted to IN A when sensor input B (IN B) is being ON
 ※ L : Circumference of the roller ※ N : Number of pulse generation from the encoder when roller rotates 1 revolution
 ※ D : diameter of roller ※ ℓ : length of processing operation
 ※ π : 3.141592

● Example of practical application

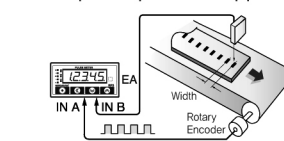

• Prescale example

Display value	Unit	Prescale value(α)
pulse gap	mm	1000 ℓ
	cm	100 ℓ
	m	1 ℓ
	EA	1 (default value)

• Default setting : EA

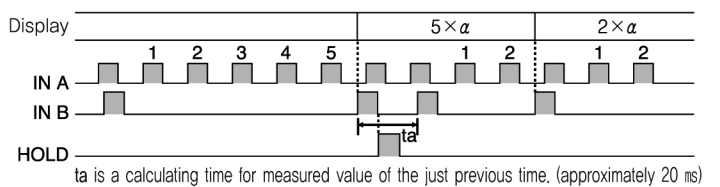

■ Mode **F 9** : accumulation counter (EA)

Mode that totals and displays pulse counts entered to sensor input A (IN A) but counting is suspended when sensor input B (IN B) turns ON. The displayed value is reset to zero when a reset signal is entered.

• Counter(EA) = P × α

※ P : Pulse counts of sensor input A (IN A)
 ※ α : prescale value

● Example of practical application

• Input 0.1 to the INA pre-scale and apply DOT Position with **99999**. then display will increase by 1 as the value increases by 10.

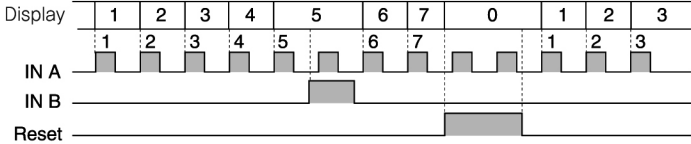
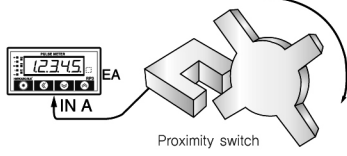

Parameter Table for each operation mode

symbol description : ○ (Yes), ×(NO)

4 Row symbol	5 Row symbol	F1	F2	F3	F4	F5	F6	F7	F8	F9	RP1,RP4	Parameter
SP Group (Comparative value Setting Group)												
SPGP	SPGrP											
-	SP HH	○	○	○	○	○	○	○	○	○		×
SP H	SP H	○	○	○	○	○	○	○	○	○		○
-	SPSET	○	○	○	○	○	○	○	○	○		×
-	SP L	○	○	○	○	○	○	○	○	○		×
-	SP LL	○	○	○	○	○	○	○	○	○		×
PS Group (Prescale or Time Option Setting Group)												
PSGP	PSGrP											
PSRū	PS Rū	○	○	×	○	×	×	○	○	○		○
PSRY	PS RY	○	○	×	○	×	×	○	○	○		○
d5dt	d5dot	○	○	×	×	×	×	○	○	○		○
d5SP	d5SAP	○	○	○	○	○	○	○	○	○		○
HYS	HYS	○	○	○	○	○	○	○	○	○		○
tl nE	tl nE	×	×	○	○	○	○	×	×	×		○
Setup Group 3 (IN/OUT Setting Group)												
SEGP	SEtGP											
FUnC	FUnCn	○	○	○	○	○	○	○	○	○		○
ln-A	ln-A	○	○	○	○	○	○	○	○	○		○
ln-b	ln-b	×	○	×	×	○	×	○	○	○		○
-	oUt-n	○	○	○	○	○	○	○	○	○		×
REtA	REtA	○	○	○	○	○	○	○	○	○		○
REtB	REtB	×	○	×	×	○	×	○	○	○		○
REtA	REtA	○	○	○	○	○	○	×	×	×		○
Option Group 4 (Option Setting Group)												
oLGP	oPtGP											
-	Pu-H	○	○	○	○	○	○	○	○	○		×
-	Pu-L	○	○	○	○	○	○	○	○	○		×
nEno	nEnor	×	×	×	×	×	×	×	×	○		○
PrLk	PrOck	○	○	○	○	○	○	○	○	○		○
Peak Display Group 5 (Peak Value Save Group)												
PEGP	PEtGP											
HPk1	HPEk1	○	○	○	○	○	○	○	○	×		○
HPk2	HPEk2	○	○	○	○	○	○	○	○	×		○
HPk3	HPEk3	○	○	○	○	○	○	○	○	×		○
HPk4	HPEk4	○	○	○	○	○	○	○	○	×		○
HPkA	HPEkA	○	○	○	○	○	○	○	○	×		○
LPk1	LPEk1	○	○	○	○	○	○	○	○	×		○
LPk2	LPEk2	○	○	○	○	○	○	○	○	×		○
LPk3	LPEk3	○	○	○	○	○	○	○	○	×		○
LPk4	LPEk4	○	○	○	○	○	○	○	○	×		○
LPkA	LPEkA	○	○	○	○	○	○	○	○	×		○

■ Default Parameter set value (5 rows)

SP Group	default value
SP HH	00000
SP H	00000
SPSET	00000
SP L	00000
SP LL	00000

PS Group	default value
PS Rū	60000
PS RY	10 1
d5dot	99999
d5SAP	005
HYS	0000
tl nE	tl nRn Sdddd

SETUP Group	default value
FUnCn	F 1
ln-A	nPnno
ln-b	nPnno
oUt-n	oUt-5
REtA	000
REtB	000
REtA	00000

Option Group	default value
Pu-H	99999
Pu-L	00000
nEnor	on
PrOck	oFF

■ Default Parameter set value (4 rows)

SP Group	default value
SP H	0000

Option Group	default value
nEno	on
PrLk	oFF

SETUP Group	default value
FUnC	F 1
ln-A	nPno
ln-b	nPno
REtA	000
REtB	000
REtA	0000

PS Group	default value
PSRū	6000
PSRY	10 1
d5dt	9999
d5SP	005
HYS	tl nE
tl nE	tl nRn Sddd

*setting might not be displayed depend on operation mode and output specification.

Output Mode **oUt-n**

■ Standard **oUt-5** mode

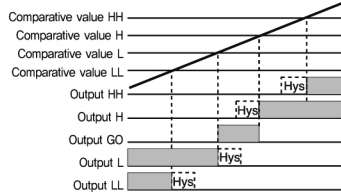

Output HH(ON) : Comparative value HH ≤ Display value
 Output H(ON) : Comparative value H ≤ Display value
 Output GO(ON) : HH, H, L, LL. Output OFF → ON
 Output L(ON) : Comparative value L ≥ Display value
 Output LL(ON) : Comparative value LL ≥ Display value

■ Zone output **oUt-3** mode

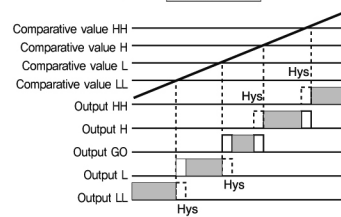

Output HH(ON) : Comparative value HH ≤ Display value
 Output H(ON) : Comparative value H ≤ Display value < Comparative value HH
 Output GO(ON) : HH, H, L, LL. Output OFF → ON
 Output L(ON) : Comparative value L < Display value ≤ Comparative value L
 Output LL(ON) : Comparative value LL ≥ Display value

■ H Level **oUt-H** mode

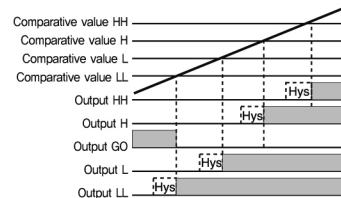

Output HH(ON) : Comparative value HH ≤ Display value
 Output H(ON) : Comparative value H ≤ Display value
 Output GO(ON) : HH, H, L, LL. Output OFF → ON
 Output L(ON) : Comparative value L ≤ Display value
 Output LL(ON) : Comparative value LL ≤ Display value

■ L Level **oUt-L** mode

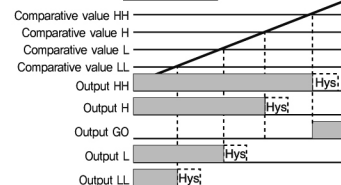

Output HH(OFF) : Comparative value HH ≤ Display value
 Output H(OFF) : Comparative value H ≤ Display value
 Output GO(ON) : HH, H, L, LL. Output OFF → ON
 Output L(OFF) : Comparative value L ≤ Display value
 Output LL(OFF) : Comparative value LL ≤ Display value

ONE short **out-F** mode

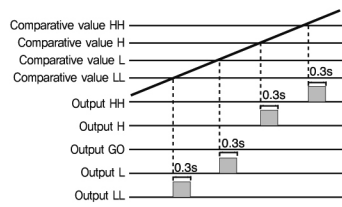

Output HH(ON) : Comparative value
 $HH \leq \text{Display value}$
 Output H(ON) : Comparative value
 $H \leq \text{Display value}$
 $H < \text{Comparative value HH}$
 Output L(ON) : Comparative value
 $LL < \text{Display value}$
 $LL \leq \text{Comparative value L}$
 Output LL(ON) : Comparative value
 $LL \geq \text{Display value}$

Double variation **out-d** mode

It makes the set value to be saved and within the set values, it yields the output when the value exceeds the HH deviation, H deviation, L deviation and LL deviation.

- Set value auto-setting: Let currently displayed value to be saved by pressing **⊙** + **⊕**
- Set value display : Pressing the **⊕** key once will display the saved set value and pressing it one more time will display the current value.

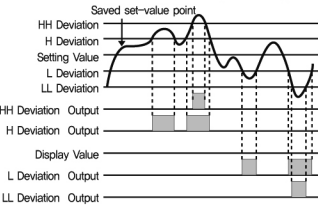

Deviation setup range : 0.0001 ~ 99999

- ※ Please refer to the Hysteresis function for Hys
- ※ Comparative value should be set as following order in order to get proper operation LL(L)<H(H)<HH(HH)
- ※ Applied only with the models RP3, RP6 and Rp7. But it is not applied with the model for indicating only.

Function Description

Auto Zero Function

If you know input pulse width, set more longer time than input pulse time width as Auto Zero value. If there is no input within setting time, displayed value will be "00000" by compulsion. Especially in case there is no pulse input within a specific period of time or when revolving object is expected to be stopped, you can set the time as Auto Zero time setting.

Starting Compensation Timer Function

After turning the power ON, it invalidates the measurement in a specific period of time. This function removes faulty outputs caused by irregularly input values such as chattering and starting current. When starting revolving object, it is especially valid in case it does not make High Comparative(H), Low Comparative(L,LL) judgment by means of low speed revolution. (Setting time : 0.1 sec ~ 99.9 sec)

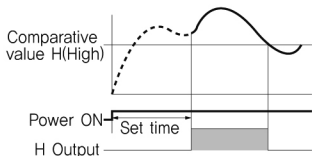

(RP1, RP4 Model)

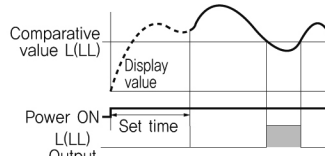

(RP3, RP6, RP7 Model)

Time Unit Selection Function

It is efficient that measurement value could be selected and displayed with various time units.

- Available time units : Decimal system and Sexagesimal system.
- Available mode : F3, F4, F5, F6

Display Cycle Setting Function

Display cycle for measured value could be selected as follows.

Available settings of display cycle = 0.05 / 0.5 / 1 / 2 / 4 / 8 sec

Peak Hold and Reset Function

This function displays Max value and Min value among displayed values. It is possible to select it by one-touch button.

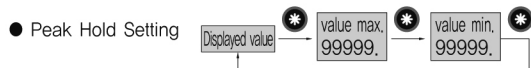

Peak Hold Storage and Confirmation

Peak Value max. : Saved in **HPEX1** ~ **HPEX4** ~ **HPEX9**

Peak Value min. : Saved in **LPEX1** ~ **LPEX4** ~ **LPEX9**

※ Each value, Max value, Min value, Peak value is stored on memory in four steps. The average value for 4 values is stored on the memory of Max, Min average value. It could be verified and cleared automatically when changing measurement mode.

※ When Max / Min value is displayed now, the very right side Dot is ON.

Hysteresis Function

In case measured value becomes unstable near comparative value, set hysteresis value based on set value in order to prevent unstable output operation. For comparative value HH,H, the decreased value is applied as hysteresis value. For comparative value LL,L, increased value is applied as the hysteresis value.
 ※ Comparative H(High value), Output H are only applicable to RP1, RP4.
 ※ Hysteresis is not applicable to "Display Only" model.

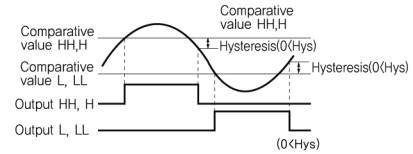

Parameter Description

※ Below parameter display signals are shown based on 5 digits. Regarding RP1 model(4 digits), please refer to page 6.

Menu Setting Flow Chart

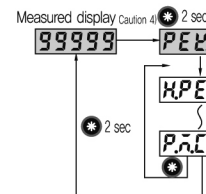
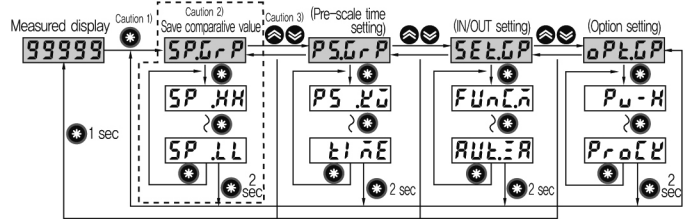

※ Note 1) Press **⊙** key for 3 seconds to enter menu mode

※ Note 2) SP Group is not shown on "Display Only" model.

※ Note 3) In each Group, you can move to other Groups by press **⊕** or **⊖** key. Pressing **⊙** key for 1 minute leads to enter into measured screen.

※ Note 4) Pressing **⊙** key for 2 seconds leads to enter into **PEELP**

※ Note 5) In case of entering into **HPEX1** out of **PEELP** please take hand off the key or press the key.

Parameter Group Flow Chart

1. SP Group [**SPGRP**]

Set menu	Setting	Setting information	Initial value
SPGRP (Display value 3 sec)	Select the comparative value setting group	In case of setting a measured value under a decimal point, below set values could be set under decimal point.	
SP.HH (0000 ~ 99999)	Set the comparative value HH ③		00000
SP.H (0000 ~ 99999)	Set the comparative value H ①		00000
SP.SET (0000 ~ 99999)	Set value (Valid only in the D output) ②	• F1, F2, F7, F8, F9 : ~ 99999 • F3, F4, F5, F6 : 0 ~ Set time range	00000
SP.L (0000 ~ 99999)	Set the comparative value L		00000
SP.LL (0000 ~ 99999)	Set the comparative value LL ③		00000

※ ① : Comparative value H(High value) setting could be shown on RP1, RP4 model.

※ ② : It is used in Output out-d only, it is not displayed on other output modes.

※ ③ : RP3, RP7 Only applicable with the model RP7 and RP3.

※ SP Group(Comparative Setting Group) is to set each output condition(HH,H,GO,L,LL). Stable output is available by setting each parameter and inputting Hysteresis value. But, "Display Only" model does not use the above parameter setting group.

※ When changing setting value : (**⊙** : change of digit, **⊕** or **⊖** : change of set value)

2. PS Group [**PSGrP**]

Set menu	Setting	Setting information	Initial value
	PSGrP Select the pre-scale setting group	Group that sets the pre-scale value of comparative value	
	PSR_X Set the Pre-scale (X) of IN A	00000~99999	60000
	PSR_Y Set the Pre-scale (Y) of IN A	10-9~10 9	10 1
	d5dot Set position of decimal point of the display value	It is possible to set the decimal point as you want. 99999.99999.9-99999.9-99999.99-99999.99-99999.9	99999.
	d5SRP Set the displaying cycle	It is possible to set the display sampling cycle as you want. 0.05-0.5-1-2-4-8	0.05
	HYS Set the hysteresis of output value	It is possible to set the Hysteresis value as you want. 0000~9999	0000
	tInE Set the input time unit (Operation ode F3,F4,F5,F6)	It is possible to set the time setting value as you want. 10-S.ddddd-5S.dddd-55S.dd-555S.d-5555S 60-5S.dddd-ññ5S.d-ñññ5S-Hññ5S-HHHññ	S.ddddd

* when changing the set value (⏪ : shift the row, ⏩ or ⏴ : change the set value)
 * Hysteresis is not displayed from N type(Display only).

3. Setup Group [**SEtGP**]

Set menu	Setting	Setting information	Initial value
	SEtGP Select the input/output control setting group	This is input/output control setting group that sets according to the input and output	
	FUnCn Set the input operation mode	F1-F9	F1
	In-R Set the IN A sensor type	nPnoo : NPN Normal Open nPnnc : NPN Normal Close PnPno : PNP Normal Open PnPnc : PNP Normal Close Conctk : Contact Normal Open nPnoo-nPnnc-PnPno-PnPnc-Conctk.	nPnoo
	In-b Set the IN B sensor type	nPnoo : NPN Normal Open nPnnc : NPN Normal Close PnPno : PNP Normal Open PnPnc : PNP Normal Close Conctk : 접점 Normal Open nPnoo-nPnnc-PnPno-PnPnc-Conctk.	nPnoo
	oUt-n Set the output mode ①	oUt-S-oUt-J-oUt-H-oUt-L-oUt-F-oUt-d	oUt-S
	RUttA Set the IN A Starting compensation timer	00.1~99.9	00.0
	RUttb Set the IN B Starting compensation timer	00.1~99.9	00.0
	RUttR Set the IN A Auto Zero timer	0000.1~9999.9	0000.0

* ① : Displayed only with the models RP3, RP6 and Rp7. But it is not displayed with the model for indication only.
 * When changing the set value (⏪ : shift the row, ⏩ or ⏴ : change the set value)

4. Option Group [**oPtGP**]

Set menu	Setting	Setting information	Initial value
	oPtGP Select the option setting group	This is option setting group that sets the option of input/output setting parameter	
	Pu-H Set the High value of PV transfer output ①	• F1, F2, F7, F8, F9 : 0 ~ 99999 • F3, F4, F5, F6 : 0 ~ Set time range	99999
	Pu-L Set the Low value of PV transfer output ①		00000

	Power failure backup setting Power failure backup setting	on : Power failure compensation(Backup) – Memorizing the previously measured value in case of off : Not use power failure compensation(Backup) on-off	on
	Parameter lock setting Parameter lock setting	off :Cancel all modes LoCK1 : P1 ~ P3 Lock LoCK3 : P3 ~ P4 Lock ALL : P1 ~ P4 Lock LoCK2 : P2 ~ P4 Lock LoCK4 : P4 Lock off-LoCK1-LoCK2-LoCK3-LoCK4-ALL	off

① : It could be displayed on the 4 – 20 mA output models.
 ② : P1(SP Group), P2(PS Group), P3(Setup Group), P4(Option Group)
 ※ When changing setting value : (⏪ : shift the row, ⏩ or ⏴ : change of set value)

5. Peak Display Group [PEKGP]

Set menu	Meaning	Setting information	Initial value
	Peak value saving group	Save the max and min of peak values divided into 10 stages individually	
HPEK1	Max value among the HIGH peak values	Save the highest value among the HIGH peak values	00000
HPEK2	2nd highest values among the HIGH peak values	Save the 2nd highest value among the HIGH peak values	00000
HPEK3	3rd highest values among the HIGH peak values	Save the 3rd highest value among the HIGH peak values	00000
HPEK4	4th highest values among the HIGH peak values	Save the 4th highest value among the HIGH peak values	00000
HPEKA	Average value of 4 HIGH peak values	Calculate the average values of 4 saved HIGH peak values and save it	00000
LPEK1	Min value among the LOW peak values	Save the lowest value among the LOW peak values	00000
LPEK2	2nd lowest values among the LOW peak values	Save the 2nd lowest value among the LOW peak values	00000
LPEK3	3rd lowest values among the LOW peak values	Save the 3rd lowest value among the LOW peak values	00000
LPEK4	4th lowest values among the LOW peak values	Save the 4th lowest value among the LOW peak values	00000
LPEKA	Average value of 4 LOW peak values	Calculate the average values of 4 saved LOW peak values and save it	00000
	Delete the peak value memory	Delete all of currently saved values	

※ The values saved in the Peak Display Value are not possible to be corrected respectively. In this case, it needs to erase all values collectively.
 ※ Saved peak values will be erased automatically in case of changing mode or power ON/OFF.
 ※ When changing setting value : (⏪ : shift the row, ⏩ + ⏴ : change of set value)

Dimension and panel cutout

[Unit : mm]

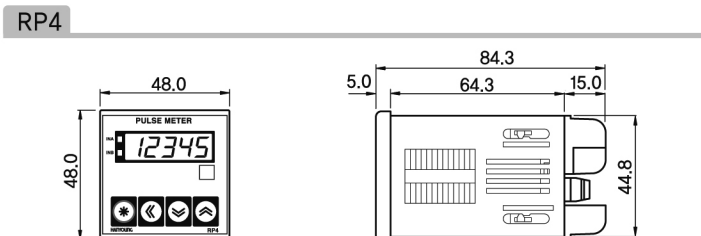
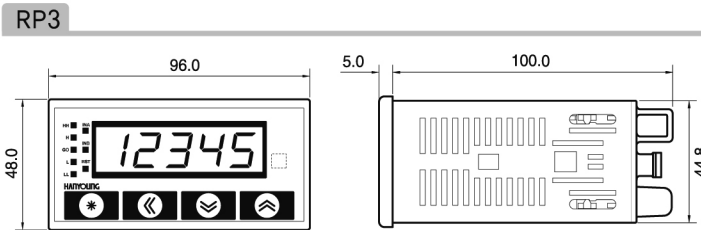
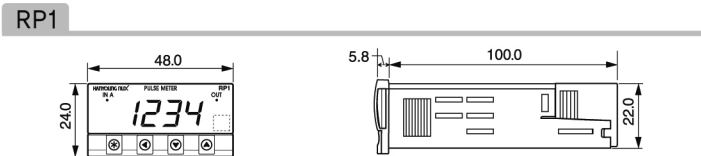

RP6

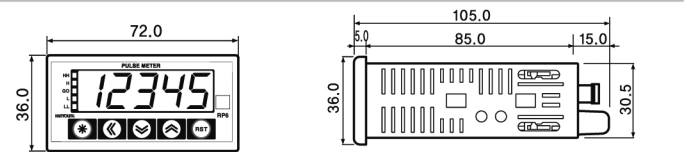

RP7

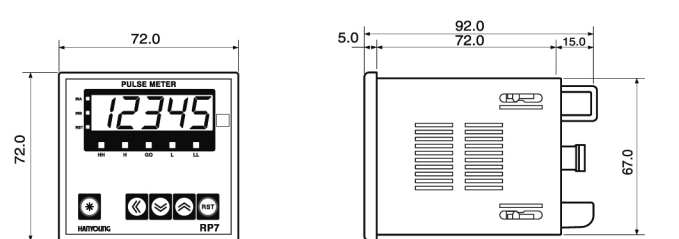

Panel cutout

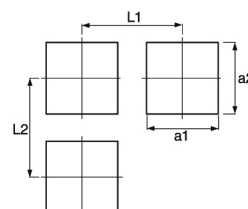

	RP1	RP3	RP4	RP6	RP7
a1	45.0 ^{+0.5} ₀	91.0 ^{+0.8} ₀	45.0 ^{+0.6} ₀	66.5 ^{+0.5} ₀	68.0 ^{+0.7} ₀
a2	22.4 ^{+0.5} ₀	45.0 ^{+0.6} ₀	45.0 ^{+0.6} ₀	32.0 ^{+0.5} ₀	68.0 ^{+0.7} ₀
L1	65.0 ^{+0.5} ₀	more than 121	more than 60	more than 96	more than 82
L2	42.4 ^{+0.5} ₀	more than 70	more than 60	more than 57	more than 82

WIRING DIAGRAM

RP1

- Display only [RP1 - 4AN]

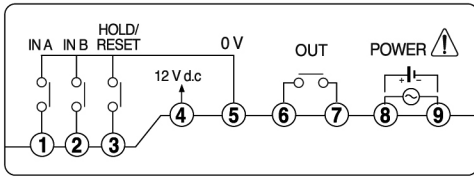

- ※ There isn't output(OUT) in case of displaying only
- ※ There is only output(OUT) in case of relay high output

RP3

- Display only (RP3-5□N)

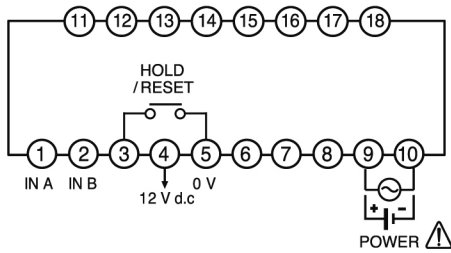

- 3 points Contact Output (RP3-5□1)

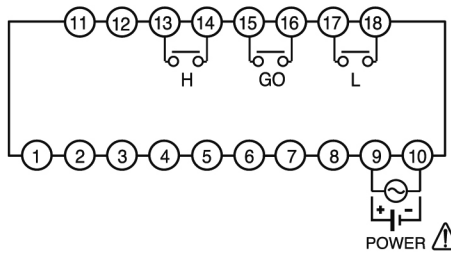

- 5 points Contact Output (RP3-5□2)

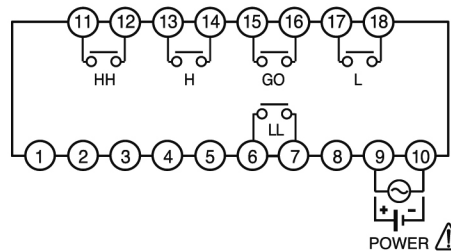

- NPN Open Collector + transfer output (4 - 20 mA d.c) (RP3-5□4)

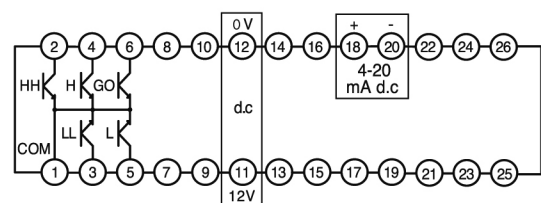
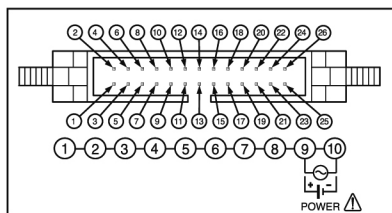

- It is Hirose connector HIF3BA-26PA-2.54DS and commonly used with the auxiliary connector.
- When purchasing this product, socket of connector is excluded.

RP4

- Display only (RP4-5□N)
- Relay High Limit Output (RP4-5□1)

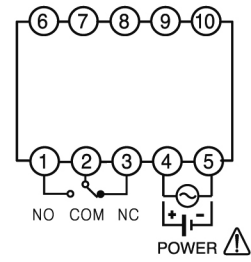
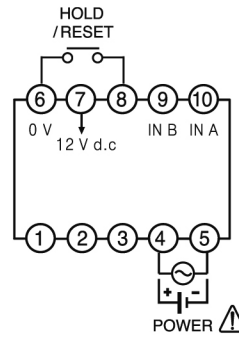

RP6

- Display only (RP6-5□N)
- 3 points Contact Output (RP6-5□1)

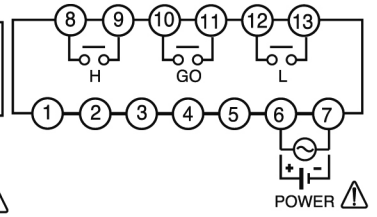
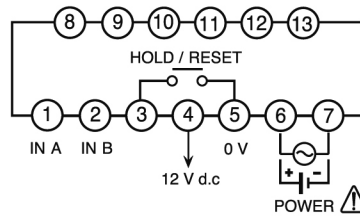

- NPN Open Collector + transfer output (4 - 20 mA d.c) (RP6-5□3)

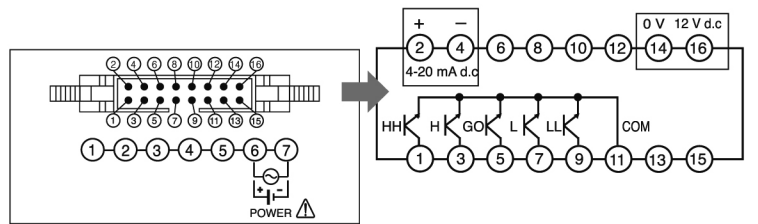

- It is Hirose connector HIF3BA-16PA-2.54DS and commonly used with the auxiliary connector.
- When purchasing this product, socket of connector is excluded.

RP7

- Display only (RP7-5□N)
- 3 points Contact Output (RP7-5□1)

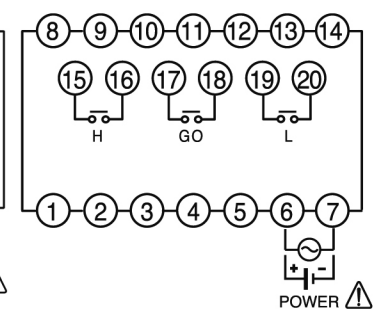
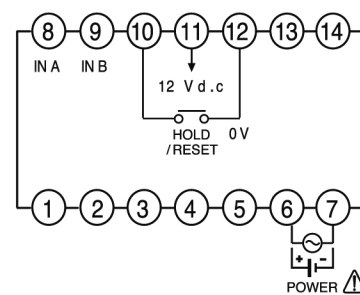

- NPN Open Collector + transfer output (4 - 20 mA d.c) (RP7-5□5)

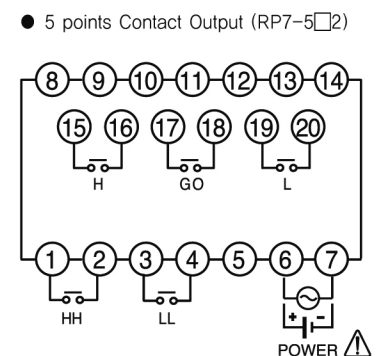
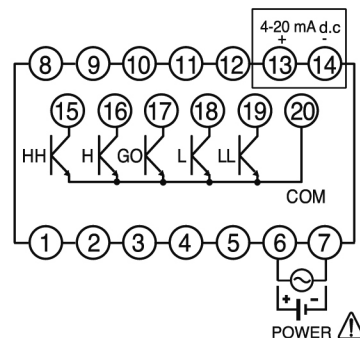

- It is Hirose connector HIF3BA-26PA-2.54DS and commonly used with the auxiliary connector.
- When purchasing this product, socket of connector is excluded.